



REPUBLIC OF THE PHILIPPINES  
DEPARTMENT OF BUDGET AND MANAGEMENT  
GENERAL SOLANO ST., SAN MIGUEL, MANILA

# BIDDING DOCUMENTS

## FOR THE

### ROOFING WITH CATWALK STRUCTURAL

## TABLE OF CONTENTS

<b>SECTION I. INVITATION TO BID.....</b>	<b>3</b>
<b>SECTION II. INSTRUCTIONS TO BIDDERS.....</b>	<b>5</b>
<b>SECTION III. BID DATA SHEET .....</b>	<b>30</b>
<b>SECTION IV. GENERAL CONDITIONS OF CONTRACT.....</b>	<b>35</b>
<b>SECTION V. SPECIAL CONDITIONS OF CONTRACT .....</b>	<b>66</b>
<b>SECTION VI. SPECIFICATIONS .....</b>	<b>68</b>
<b>SECTION VII. DRAWINGS .....</b>	<b>71</b>
<b>SECTION VIII. BILL OF QUANTITIES .....</b>	<b>72</b>
<b>SECTION IX. BIDDING FORMS .....</b>	<b>73</b>



REPUBLIC OF THE PHILIPPINES  
DEPARTMENT OF BUDGET AND MANAGEMENT  
GENERAL SOLANO ST., SAN MIGUEL, MANILA

**Section I. Invitation to Bid**  
***Roofing with Catwalk Structural***

1. The Department of Budget and Management (DBM) through the authorized appropriations under the 2014 General Appropriations Act intends to apply the sum of **THREE MILLION SEVEN HUNDRED TWELVE THOUSAND PESOS (P3,712,000.00)** being the Approved Budget for the Contract (ABC) to payments under the contract for the **Roofing with Catwalk Structural**. Bids received in excess of the ABC shall be automatically rejected at bid opening.
2. The DBM now invites bids for the **Repair/Rehabilitation of DBM Building II Roofs and Gutters and Installation of Roof Catwalk**. Delivery of the Services shall be in accordance with the delivery schedule under Section VI, Specifications. Bidders should have completed, within ten (10) years prior to May 14, 2014, a contract similar to the Project. The description of an eligible bidder is contained in the Bidding Documents, particularly, in Section II. Instructions to Bidders (ITB).
3. Bidding will be conducted through open competitive bidding procedures using a non-discretionary “pass/fail” criterion as specified in the Implementing Rules and Regulations (IRR) of Republic Act (R.A.) No. 9184, otherwise known as the “Government Procurement Reform Act.”

Bidding is restricted to Filipino citizens/sole proprietorships, partnerships, or organizations with at least sixty percent (75%) interest or outstanding capital stock belonging to citizens of the Philippines, and to citizens or organizations of a country the laws or regulations of which grant similar rights or privileges to Filipino citizens, pursuant to RA 5183 and subject to Commonwealth Act 138.

4. Interested bidders may obtain further information from the DBM Bids and Awards Committee (BAC) Secretariat and inspect the Bidding Documents at the address given below during office hours from 9:00 a.m. to 4:00 p.m.
5. A complete set of Bidding Documents may be purchased by interested Bidders on May 7, 2014 from the address below and upon payment of a non-refundable fee in the amount of ₱3,500.00. It may also be downloaded free of charge from the website of the Philippine Government Electronic Procurement System (PhilGEPS) and the website of the DBM, provided that Bidders shall pay the nonrefundable fee for the Bidding Documents not later than the submission of their bids.
6. The DBM will hold a Pre-Bid Conference on May 14, 2014, 11:00 a.m. at BAC Room, Ground Floor, DBM Building III, General Solano St., San Miguel, Manila which shall be open to all interested parties.

7. Bids must be delivered to the address below on or before May 27, 2014, 11:00 a.m. All Bids must be accompanied by a bid security in any of the acceptable forms and in the amount stated in the **ITB** Clause 18.

Bid opening shall be on May 27, 2014, 11:00 a.m at BAC Room, Ground Floor, DBM Building III, General Solano St., San Miguel, Manila. Bids will be opened in the presence of the Bidders' representatives who choose to attend at the address below. Late bids shall not be accepted.

8. The bidders shall drop three (3) copies of their duly accomplished eligibility and technical requirements, and the financial component of the bid in two (2) separate sealed envelopes in the bid box located at the above-mentioned address.
9. The DBM reserves the right to accept or reject any bid, to annul the bidding process, and to reject all bids at any time prior to contract award, without thereby incurring any liability to the affected bidder or bidders.
10. For further information, please refer to:

DBM-BAC Secretariat  
Department of Budget and Management  
General Solano St., San Miguel, Manila  
Telfax No. 4901000 loc. 3121  
Email address: jabrigo@dbm.gov.ph

**ATTY. JANET B. ABUEL**  
*Assistant Secretary*  
*Chairperson, DBM-BAC*

## Section II. Instructions to Bidders

### TABLE OF CONTENTS

<b>A. GENERAL .....</b>	<b>7</b>
1. Scope of Bid.....	7
2. Source of Funds .....	7
3. Corrupt, Fraudulent, Collusive, and Coercive Practices .....	7
4. Conflict of Interest .....	8
5. Eligible Bidders.....	9
6. Bidder’s Responsibilities .....	11
7. Origin of GOODS and Services.....	12
8. Subcontracts .....	13
<b>B. CONTENTS OF BIDDING DOCUMENTS .....</b>	<b>13</b>
9. Pre-Bid Conference.....	13
10. Clarification and Amendment of Bidding Documents.....	13
<b>C. PREPARATION OF BIDS .....</b>	<b>14</b>
11. Language of Bids .....	14
12. Documents Comprising the Bid: Eligibility and Technical Components.....	14
13. Documents Comprising the Bid: Financial Component .....	16
14. Alternative Bids .....	16
15. Bid Prices .....	17
16. Bid Currencies.....	17
17. Bid Validity.....	18
18. Bid Security.....	18
19. Format and Signing of Bids .....	19
20. Sealing and Marking of Bids .....	20
<b>D. SUBMISSION AND OPENING OF BIDS.....</b>	<b>21</b>
21. Deadline for Submission of Bids .....	21
22. Late Bids .....	21
23. Modification and Withdrawal of Bids .....	21
24. Opening and Preliminary Examination of Bids .....	21
<b>E. EVALUATION AND COMPARISON OF BIDS.....</b>	<b>23</b>
25. Process to be Confidential.....	23

26.	Clarification of Bids.....	23
27.	Detailed Evaluation and Comparison of Bids.....	23
28.	Post Qualification.....	24
29.	Reservation Clause.....	25
<b>F.</b>	<b>AWARD OF CONTRACT .....</b>	<b>26</b>
30.	Contract Award .....	26
31.	Signing of the Contract .....	27
32.	Performance Security .....	28
33.	Notice to Proceed .....	28

## **A. General**

### **1. Scope of Bid**

- 1.1. The Procuring Entity as defined in the **BDS**, invites bids for the construction of Works, as described in Section VI. Specifications. The name and identification number of the Contract is provided in the **BDS**.
- 1.2. The successful bidder will be expected to complete the Works by the intended completion date specified in SCC Clause 1.16.

### **2. Source of Funds**

The Procuring Entity has a budget or has applied for or received funds from the Funding Source named in the **BDS**, and in the amount indicated in the **BDS**. It intends to apply part of the funds received for the Project, as defined in the **BDS**, to cover eligible payments under the Contract for the Works.

### **3. Corrupt, Fraudulent, Collusive, and Coercive Practices**

- 3.1. The Procuring Entity, as well as bidders and contractors, shall observe the highest standard of ethics during the procurement and execution of the contract. In pursuance of this policy, the Funding Source:
  - (a) defines, for purposes of this provision, the terms set forth below as follows:
    - (i) "corrupt practice" means behavior on the part of officials in the public or private sectors by which they improperly and unlawfully enrich themselves, others, or induce others to do so, by misusing the position in which they are placed, and includes the offering, giving, receiving, or soliciting of anything of value to influence the action of any such official in the procurement process or in contract execution; entering, on behalf of the Procuring Entity, into any contract or transaction manifestly and grossly disadvantageous to the same, whether or not the public officer profited or will profit thereby, and similar acts as provided in Republic Act 3019;
    - (ii) "fraudulent practice" means a misrepresentation of facts in order to influence a procurement process or the execution of a contract to the detriment of the Procuring Entity, and includes collusive practices among Bidders (prior to or after Bid submission) designed to establish bid prices at artificial, non-competitive levels and to deprive the Procuring Entity of the benefits of free and open competition;
    - (iii) "collusive practices" means a scheme or arrangement between two or more bidders, with or without the knowledge of the Procuring Entity, designed to establish bid prices at artificial, non-competitive levels; and

- (iv) “coercive practices” means harming or threatening to harm, directly or indirectly, persons, or their property to influence their participation in a procurement process, or affect the execution of a contract;
  - (b) will reject a proposal for award if it determines that the bidder recommended for award has engaged in corrupt or fraudulent practices in competing for the Contract; and
  - (c) will declare a firm ineligible, either indefinitely or for a stated period of time, to be awarded Contract funded by the Funding Source if it at any time determines that the firm has engaged in corrupt or fraudulent practices in competing or, or in executing, a Contract funded by the Funding Source.
- 3.2. Further, the Procuring Entity will seek to impose the maximum civil, administrative, and/or criminal penalties available under the applicable laws on individuals and organizations deemed to be involved in any of the practices mentioned in **ITB** Clause 3.1(a).
- 3.3. Furthermore, the Funding Source and the Procuring Entity reserve the right to inspect and audit records and accounts of a contractor in the bidding for and performance of a contract themselves or through independent auditors as reflected in the **GCC** Clause 34.

#### **4. Conflict of Interest**

- 4.1. All bidders found to have conflicting interests shall be disqualified to participate in the procurement at hand, without prejudice to the imposition of appropriate administrative, civil, and criminal sanctions. A Bidder may be considered to have conflicting interests with another Bidder in any of the events described in paragraphs (a) through (c) and a general conflict of interest in any of the circumstances set out in paragraphs (d) through (g) below:
  - (a) A Bidder has controlling shareholders in common with another Bidder;
  - (b) A Bidder receives or has received any direct or indirect subsidy from any other Bidder;
  - (c) A Bidder has the same legal representative as that of another Bidder for purposes of this Bid;
  - (d) A Bidder has a relationship, directly or through third parties, that puts them in a position to have access to information about or influence on the bid of another Bidder or influence the decisions of the Procuring Entity regarding this bidding process. This will include a firm or an organization who lends, or temporarily seconds, its personnel to firms or organizations which are engaged in consulting services for the preparation related to procurement for or implementation of the project if the personnel would be involved in any capacity on the same project;



- (e) A Bidder submits more than one bid in this bidding process. However, this does not limit the participation of subcontractors in more than one bid;
- (f) A Bidder who participated as a consultant in the preparation of the design or technical specifications of the goods and related services that are the subject of the bid; or
- (g) A Bidder who lends, or temporary seconds, its personnel to firms or organizations which are engaged in consulting services for the preparation related to procurement for or implementation of the project, if the personnel would be involved in any capacity on the same project.

4.2. In accordance with Section 47 of the IRR of RA 9184, all Bidding Documents shall be accompanied by a sworn affidavit of the Bidder that it is not related to the Head of the Procuring Entity, members of the Bids and Awards Committee (BAC), members of the Technical Working Group (TWG), members of the BAC Secretariat, the head of the Project Management Office (PMO) or the end-user unit, and the project consultants, by consanguinity or affinity up to the third civil degree. On the part of the bidder, this Clause shall apply to the following persons:

- (a) If the Bidder is an individual or a sole proprietorship, to the Bidder himself;
- (b) If the Bidder is a partnership, to all its officers and members;
- (c) If the Bidder is a corporation, to all its officers, directors, and controlling stockholders; and
- (d) If the Bidder is a joint venture (JV), the provisions of items (a), (b), or (c) of this Clause shall correspondingly apply to each of the members of the said JV, as may be appropriate.

Relationship of the nature described above or failure to comply with this Clause will result in the automatic disqualification of a Bidder.

## 5. Eligible Bidders

5.1. Unless otherwise indicated in the **BDS**, the following persons shall be eligible to participate in this Bidding:

- (a) Duly licensed Filipino citizens/sole proprietorships;
- (b) Partnerships duly organized under the laws of the Philippines and of which at least seventy five percent (75%) of the interest belongs to citizens of the Philippines;
- (c) Corporations duly organized under the laws of the Philippines, and of which at least seventy five percent (75%) of the outstanding capital stock belongs to citizens of the Philippines;

- (d) Cooperatives duly organized under the laws of the Philippines, and of which at least seventy five percent (75%) of the interest belongs to citizens of the Philippines; and
- (e) Persons/entities forming themselves into a JV, i.e., a group of two (2) or more persons/entities that intend to be jointly and severally responsible or liable for a particular contract: Provided, however, that, in accordance with Letter of Instructions No. 630, Filipino ownership or interest of the joint venture concerned shall be at least seventy five percent (75%): Provided, further, that joint ventures in which Filipino ownership or interest is less than seventy five percent (75%) may be eligible where the structures to be built require the application of techniques and/or technologies which are not adequately possessed by a person/entity meeting the seventy five percent (75%) Filipino ownership requirement: Provided, finally, that in the latter case, Filipino ownership or interest shall not be less than twenty five percent (25%). For this purpose Filipino ownership or interest shall be based on the contributions of each of the members of the joint venture as specified in their JVA.

- 5.2. The Procuring Entity may also invite foreign bidders when provided for under any Treaty or International or Executive Agreement as specified in the **BDS**.
- 5.3. Government Corporate Entities may be eligible to participate only if they can establish that they (a) are legally and financially autonomous, (b) operate under commercial law, and (c) are not dependent agencies of the GOP or the Procuring Entity.
- 5.4. Unless otherwise provided in the **BDS**, the Bidder must have completed at least one contract similar to the Project the value of which, adjusted to current prices using the National Statistics Office consumer price index, must be at least equivalent to a percentage of the ABC stated in the **BDS**.

For this purpose, contracts similar to the Project shall be those described in the **BDS**, and completed within the period stated in the Invitation to Bid and **ITB** Clause 12.1(a)(iii).

- 5.5. Unless otherwise provided in the **BDS**, the Bidder must submit a computation of its Net Financial Contracting Capacity (NFCC) or a Commitment from a Universal or Commercial bank to extend a credit line in its favor if awarded the contract for this project (CLC).

The NFCC, computed using the following formula, must be at least equal to the ABC to be bid:

NFCC = [(Current assets minus current liabilities) (K)] minus the value of all outstanding or uncompleted portions of the projects under ongoing contracts, including awarded contracts yet to be started coinciding with the contract for this Project.

Where:

K = 10 for a contract duration of one year or less, 15 for a contract duration of more than one year up to two years, and 20 for a contract duration of more than two years.

The CLC must be at least equal to ten percent (10%) of the ABC for this Project. If issued by a foreign bank, it shall be confirmed or authenticated by a Universal or Commercial Bank. In the case of local government units (LGUs), the Bidder may also submit CLC from other banks certified by the *Bangko Sentral ng Pilipinas* (BSP) as authorized to issue such financial instrument.

## 6. Bidder's Responsibilities

- 6.1. The Bidder or its duly authorized representative shall submit a sworn statement in the form prescribed in **Error! Reference source not found.** as required in **ITB** Clause 12.1(b)(iii).
- 6.2. The Bidder is responsible for the following:
  - (a) Having taken steps to carefully examine all of the Bidding Documents;
  - (b) Having acknowledged all conditions, local or otherwise, affecting the implementation of the contract;
  - (c) Having made an estimate of the facilities available and needed for the contract to be bid, if any;
  - (d) Having complied with its responsibility to inquire or secure Supplemental/Bid Bulletin/s as provided under **ITB** Clause 10.3.
  - (e) Ensuring that it is not "blacklisted" or barred from bidding by the GOP or any of its agencies, offices, corporations, or LGUs, including foreign government/foreign or international financing institution whose blacklisting rules have been recognized by the GPPB;
  - (f) Ensuring that each of the documents submitted in satisfaction of the bidding requirements is an authentic copy of the original, complete, and all statements and information provided therein are true and correct;
  - (g) Authorizing the Head of the Procuring Entity or its duly authorized representative/s to verify all the documents submitted;
  - (h) Ensuring that the signatory is the duly authorized representative of the Bidder, and granted full power and authority to do, execute and perform any and all acts necessary and/or to represent the Bidder in the bidding, with the duly notarized Secretary's Certificate attesting to such fact, if the Bidder is a corporation, partnership, cooperative, or joint venture;

- (i) Complying with the disclosure provision under Section 47 of the Act in relation to other provisions of Republic Act 3019; and
- (j) Complying with existing labor laws and standards, if applicable.

Failure to observe any of the above responsibilities shall be at the risk of the Bidder concerned.

- 6.3. The Bidder, by the act of submitting its bid, shall be deemed to have inspected the site and determined the general characteristics of the contract works and the conditions for this Project. Unless otherwise indicated in the **BDS**, failure to furnish all information or documentation required in this Bidding Documents shall result in the rejection of the bid and the disqualification of the Bidder.
- 6.4. It shall be the sole responsibility of the prospective bidder to determine and to satisfy itself by such means as it considers necessary or desirable as to all matters pertaining to this Project, including: (a) the location and the nature of the contract, project, or work; (b) climatic conditions; (c) transportation facilities; (c) nature and condition of the terrain, geological conditions at the site communication facilities, requirements, location and availability of construction aggregates and other materials, labor, water, electric power and access roads; and (d) other factors that may affect the cost, duration and execution or implementation of the contract, project, or work.
- 6.5. The Procuring Entity shall not assume any responsibility regarding erroneous interpretations or conclusions by the prospective or eligible bidder out of the data furnished by the procuring entity.
- 6.6. Before submitting their bids, the Bidders are deemed to have become familiar with all existing laws, decrees, ordinances, acts and regulations of the Philippines which may affect the contract in any way.
- 6.7. The Bidder shall bear all costs associated with the preparation and submission of his bid, and the Procuring Entity will in no case be responsible or liable for those costs, regardless of the conduct or outcome of the bidding process.
- 6.8. Bidders should note that the Procuring Entity will only accept bids only from those that have paid the nonrefundable fee for the Bidding Documents at the office indicated in the Invitation to Bid.

## **7. Origin of GOODS and Services**

Unless otherwise indicated in the **BDS**, there is no restriction on the origin of Goods, or Contracting of Works or Services other than those prohibited by a decision of the United Nations Security Council taken under Chapter VII of the Charter of the United Nations.

## **8. Subcontracts**

- 8.1. Unless otherwise specified in the **BDS**, the Bidder may subcontract portions of the Works to an extent as may be approved by the Procuring Entity and stated in the **BDS**. However, subcontracting of any portion shall not relieve the Bidder from any liability or obligation that may arise from the contract for this Project.
- 8.2. Subcontractors must submit the documentary requirements under **ITB** Clause 12 and comply with the eligibility criteria specified in the **BDS**. In the event that any subcontractor is found by the Procuring Entity to be ineligible, the subcontracting of such portion of the Works shall be disallowed.
- 8.3. The Bidder may identify the subcontractor to whom a portion of the Works will be subcontracted at any stage of the bidding process or during contract implementation. If the Bidder opts to disclose the name of the subcontractor during bid submission, the Bidder shall include the required documents as part of the technical component of its bid.

### **B. Contents of Bidding Documents**

## **9. Pre-Bid Conference**

- 9.1. If so specified in the **BDS**, a pre-bid conference shall be held at the venue and on the date indicated therein, to clarify and address the Bidders' questions on the technical and financial components of this Project.
- 9.2. Bidders are encouraged to attend the pre-bid conference to ensure that they fully understand the Procuring Entity's requirements. Non-attendance of the Bidder will in no way prejudice its bid; however, the Bidder is expected to know the changes and/or amendments to the Bidding Documents discussed during the pre-bid conference.
- 9.3. Any statement made at the pre-bid conference shall not modify the terms of the bidding documents unless such statement is specifically identified in writing as an amendment thereto and issued as a Supplemental/Bid Bulletin.

## **10. Clarification and Amendment of Bidding Documents**

- 10.1. Bidders who have purchased the Bidding Documents may request for clarification(s) on any part of the Bidding Documents or for an interpretation. Such a request must be in writing and submitted to the Procuring Entity at the address indicated in the **BDS** at least ten (10) calendar days before the deadline set for the submission and receipt of Bids.
- 10.2. Supplemental/Bid Bulletins may be issued upon the Procuring Entity's initiative for purposes of clarifying or modifying any provision of the Bidding Documents not later than seven (7) calendar days before the deadline for the submission and receipt of Bids. Any modification to the Bidding Documents shall be identified as an amendment.

- 10.3. Any Supplemental/Bid Bulletin issued by the BAC shall also be posted on the Philippine Government Electronic Procurement System (PhilGEPS) and the website of the Procuring Entity concerned, if available. It shall be the responsibility of all Bidders who secure the Bidding Documents to inquire and secure Supplemental/Bid Bulletins that may be issued by the BAC. However, bidders who have submitted bids before the issuance of the Supplemental/Bid Bulletin must be informed and allowed to modify or withdraw their bids in accordance with **ITB** Clause 23.

## **C. Preparation of Bids**

### **11. Language of Bids**

The Bid, as well as all correspondence and documents relating to the Bid exchanged by the Bidder and the Procuring Entity, shall be written in English. Supporting documents and printed literature furnished by the Bidder may be in another language provided they are accompanied by an accurate translation in English certified by the appropriate embassy or consulate in the Philippines, in which case the English translation shall govern, for purposes of interpretation of the Bid.

### **12. Documents Comprising the Bid: Eligibility and Technical Components**

- 12.1. Unless otherwise indicated in the **BDS**, the first envelope shall contain the following eligibility and technical documents:

- (a) Eligibility Documents –

Class "A" Documents:

- (i) Registration certificate from the Securities and Exchange Commission (SEC), Department of Trade and Industry (DTI) for sole proprietorship, or Cooperative Development Authority (CDA) for cooperatives, or any proof of such registration as stated in the **BDS**;
- (ii) Mayor's permit issued by the city or municipality where the principal place of business of the prospective bidder is located;
- (iii) Statement of all its ongoing and completed government and private contracts within ten (10) years from the submission of bids, unless otherwise stated in the **BDS**, including contracts awarded but not yet started, if any. The statement shall include, for each contract, the following:
  - (iii.1) name of the contract;
  - (iii.2) date of the contract;
  - (iii.3) contract duration;

- (iii.4) owner's name and address;
- (iii.5) nature of work;
- (iii.6) contractor's role (whether sole contractor, subcontractor, or partner in a JV) and percentage of participation;
- (iii.7) total contract value at award;
- (iii.8) date of completion or estimated completion time;
- (iii.9) total contract value at completion, if applicable;
- (iii.10) percentages of planned and actual accomplishments, if applicable;
- (iii.11) value of outstanding works, if applicable;
- (iii.12) the statement shall be supported by the notices of award and/or notices to proceed issued by the owners; and
- (iii.13) the statement shall be supported by the Constructors Performance Evaluation System (CPES) rating sheets, and/or certificates of completion and owner's acceptance, if applicable;
- (iv) Unless otherwise provided in the **BDS**, valid Philippine Contractors Accreditation Board (PCAB) license and registration for the type and cost of the contract for this Project;
- (v) Audited financial statements, showing, among others, the prospective total and current assets and liabilities, stamped "received" by the BIR or its duly accredited and authorized institutions, for the preceding calendar year which should not be earlier than two (2) years from the date of bid submission;
- (vi) NFCC computation or CLC in accordance with **ITB** Clause 5.5; and

Class "B" Document:

- (vii) If applicable, valid Joint Venture Agreement (JVA) or, in lieu thereof, duly notarized statements from all the potential joint venture partners stating that they will enter into and abide by the provisions of the JVA in the instance that the bid is successful shall be included in the bid.
- (b) Technical Documents –
  - (i) Bid security as prescribed in **ITB** Clause 18. If the Bidder opts to submit the bid security in the form of:

- (i.1) a bank draft/guarantee or an irrevocable letter of credit issued by a foreign bank, it shall be accompanied by a confirmation from a Universal or Commercial Bank; or
- (i.2) a surety bond accompanied by a certification coming from an authorized Insurance Commission that a surety or insurance company is authorized to issue such instrument;
- (ii) Project Requirements, which shall include the following:
  - (ii.1) Organizational chart for the contract to be bid;
  - (ii.2) List of contractor's personnel (*viz.*, project Manager, Project Engineers, Materials Engineers, and Foremen), to be assigned to the contract to be bid, with their complete qualification and experience data; and
  - (ii.3) List of contractor's equipment units, which are owned, leased, and/or under purchase agreements, supported by certification of availability of equipment from the equipment lessor/vendor for the duration of the project; and
- (iii) Sworn statement in accordance with Section 25.2(b)(iv) of the IRR of RA 9184 and using the form prescribed in **Error! Reference source not found..**

### **13. Documents Comprising the Bid: Financial Component**

- 13.1. Unless otherwise stated in the **BDS**, the financial component of the bid shall contain the following:
  - (a) Financial Bid Form in accordance with the form prescribed in **Error! Reference source not found.**; and
  - (b) Any other document required in the **BDS**.
- 13.2. Unless indicated in the **BDS**, all Bids that exceed the ABC shall not be accepted.

### **14. Alternative Bids**

- 14.1. Alternative Bids shall be rejected. For this purpose, alternative bid is an offer made by a Bidder in addition or as a substitute to its original bid which may be included as part of its original bid or submitted separately therewith for purposes of bidding. A bid with options is considered an alternative bid regardless of whether said bid proposal is contained in a single envelope or submitted in two (2) or more separate bid envelopes.
- 14.2. Bidders shall submit offers that comply with the requirements of the Bidding Documents, including the basic technical design as indicated in the drawings



and specifications. Unless there is a value engineering clause in the **BDS**, alternative bids shall not be accepted.

- 14.3. Each Bidder shall submit only one Bid, either individually or as a partner in a JV. A Bidder who submits or participates in more than one bid (other than as a subcontractor if a subcontractor is permitted to participate in more than one bid) will cause all the proposals with the Bidder's participation to be disqualified. This shall be without prejudice to any applicable criminal, civil and administrative penalties that may be imposed upon the persons and entities concerned.

## **15. Bid Prices**

- 15.1. The contract shall be for the whole Works, as described in **ITB** Clause 1.1, based on the priced Bill of Quantities submitted by the Bidder.
- 15.2. The Bidder shall fill in rates and prices for all items of the Works described in the Bill of Quantities. Bids not addressing or providing all of the required items in the Bidding Documents including, where applicable, bill of quantities, shall be considered non-responsive and, thus, automatically disqualified. In this regard, where a required item is provided, but no price is indicated, the same shall be considered as non-responsive, but specifying a "0" (zero) for the said item would mean that it is being offered for free to the Government.
- 15.3. All duties, taxes, and other levies payable by the Contractor under the Contract, or for any other cause, prior to the deadline for submission of bids, shall be included in the rates, prices, and total bid price submitted by the Bidder.
- 15.4. Unless otherwise provided in the **BDS**, all bid prices for the given scope of work in the contract as awarded shall be considered as fixed prices, and therefore not subject to price escalation during contract implementation, except under extraordinary circumstances as indicated in the **BDS** and specified in **GCC** Clause 48 and its corresponding **SCC** provision.

## **16. Bid Currencies**

- 16.1. All bid prices shall be quoted in Philippine Pesos unless otherwise provided in the **BDS**. However, for purposes of bid evaluation, bids denominated in foreign currencies shall be converted to Philippine currency based on the exchange rate prevailing on the day of the Bid opening.
- 16.2. If so allowed in accordance with **ITB** Clause 16.1, the Procuring Entity for purposes of bid evaluation and comparing the bid prices will convert the amounts in various currencies in which the bid price is expressed to Philippine Pesos at the exchange rate as published in the BSP reference rate bulletin on the day of the bid opening.
- 16.3. Unless otherwise specified in the **BDS**, payment of the contract price shall be made in Philippine Pesos.

## 17. Bid Validity

- 17.1. Bids shall remain valid for the period specified in the **BDS** which shall not exceed one hundred twenty (120) calendar days from the date of the opening of bids.
- 17.2. In exceptional circumstances, prior to the expiration of the bid validity period, the Procuring Entity may request Bidders to extend the period of validity of their bids. The request and the responses shall be made in writing. The bid security described in **ITB** Clause 18 should also be extended corresponding to the extension of the bid validity period at the least. A Bidder may refuse the request without forfeiting its bid security, but his bid shall no longer be considered for further evaluation and award. A Bidder granting the request shall not be required or permitted to modify its bid.

## 18. Bid Security

- 18.1. The bid security, issued in favor of the Procuring Entity, in the amount stated in the **BDS** shall be equal to the percentage of the ABC in accordance with the following schedule:

Form of Bid Security	Amount of Bid Security (Equal to Percentage of the ABC)
(a) Cash or cashier's/manager's check issued by a Universal or Commercial Bank.	Two percent (2%)
(b) Bank draft/guarantee or irrevocable letter of credit issued by a Universal or Commercial Bank: Provided, however, that it shall be confirmed or authenticated by a Universal or Commercial Bank, if issued by a foreign bank.	
(c) Surety bond callable upon demand issued by a surety or insurance company duly certified by the Insurance Commission as authorized to issue such security; and/or	Five percent (5%)
(d) Any combination of the foregoing.	Proportionate to share of form with respect to total amount of security

For biddings conducted by local government units, the Bidder may also submit bid securities in the form of cashier's/manager's check, bank draft/guarantee, or irrevocable letter of credit from other banks certified by the BSP as authorized to issue such financial statement.

- 18.2. The bid security should be valid for the period specified in the **BDS**. Any bid not accompanied by an acceptable bid security shall be rejected by the Procuring Entity as non-responsive.
- 18.3. No bid securities shall be returned to bidders after the opening of bids and before contract signing, except to those that failed or declared as post-disqualified, upon submission of a written waiver of their right to file a motion for reconsideration and/or protest. Without prejudice on its forfeiture, Bid Securities shall be returned only after the bidder with the Lowest Calculated Responsive Bid has signed the contract and furnished the Performance Security, but in no case later than the expiration of the Bid Security validity period indicated in **ITB** Clause 18.2.
- 18.4. Upon signing and execution of the contract, pursuant to **ITB** Clause 31, and the posting of the performance security, pursuant to **ITB** Clause 32, the successful Bidder's Bid security will be discharged, but in no case later than the Bid security validity period as indicated in **ITB** Clause 18.2.
- 18.5. The bid security may be forfeited:
- (a) if a Bidder:
    - (i) withdraws its bid during the period of bid validity specified in **ITB** Clause 17;
    - (ii) does not accept the correction of errors pursuant to **ITB** Clause 27.3(b);
    - (iii) fails to submit the requirements within the prescribed period, or a finding against their veracity, as stated in **ITB** Clause 28.2; or
    - (iv) any other reason stated in the **BDS**.
  - (b) if the successful Bidder:
    - (i) fails to sign the contract in accordance with **ITB** Clause 31;
    - (ii) fails to furnish performance security in accordance with **ITB** Clause 32; or
    - (iii) any other reason stated in the **BDS**.

## **19. Format and Signing of Bids**

- 19.1. Bidders shall submit their bids through their duly authorized representative using the appropriate forms provided in **Error! Reference source not found.** on or before the deadline specified in the **ITB** Clause 21 in two (2) separate sealed bid envelopes, and which shall be submitted simultaneously. The first shall contain the technical component of the bid, including the eligibility requirements under **ITB** Clause 12.1, and the second shall contain the financial component of the bid.

- 19.2. Forms as mentioned in **ITB** Clause 19.1 must be completed without any alterations to their format, and no substitute form shall be accepted. All blank spaces shall be filled in with the information requested.
- 19.3. The Bidder shall prepare an original of the first and second envelopes as described in **ITB** Clauses 12 and 13. In addition, the Bidder shall submit copies of the first and second envelopes. In the event of any discrepancy between the original and the copies, the original shall prevail.
- 19.4. The bid, except for unamended printed literature, shall be signed, and each and every page thereof shall be initialed, by the duly authorized representative/s of the Bidder.
- 19.5. Any interlineations, erasures, or overwriting shall be valid only if they are signed or initialed by the duly authorized representative/s of the Bidder.

## **20. Sealing and Marking of Bids**

- 20.1. Unless otherwise indicated in the **BDS**, Bidders shall enclose their original eligibility and technical documents described in **ITB** Clause 12, in one sealed envelope marked “ORIGINAL - TECHNICAL COMPONENT”, and the original of their financial component in another sealed envelope marked “ORIGINAL - FINANCIAL COMPONENT”, sealing them all in an outer envelope marked “ORIGINAL BID”.
- 20.2. Each copy of the first and second envelopes shall be similarly sealed duly marking the inner envelopes as “COPY NO. \_\_\_ - TECHNICAL COMPONENT” and “COPY NO. \_\_\_ – FINANCIAL COMPONENT” and the outer envelope as “COPY NO. \_\_\_”, respectively. These envelopes containing the original and the copies shall then be enclosed in one single envelope.
- 20.3. The original and the number of copies of the Bid as indicated in the **BDS** shall be typed or written in indelible ink and shall be signed by the bidder or its duly authorized representative/s.
- 20.4. All envelopes shall:
  - (a) contain the name of the contract to be bid in capital letters;
  - (b) bear the name and address of the Bidder in capital letters;
  - (c) be addressed to the Procuring Entity’s BAC identified in **ITB** Clause 10.1;
  - (d) bear the specific identification of this bidding process indicated in the Invitation to Bid; and
  - (e) bear a warning “DO NOT OPEN BEFORE...” the date and time for the opening of bids, in accordance with **ITB** Clause 21.

- 20.5. If bids are not sealed and marked as required, the Procuring Entity will assume no responsibility for the misplacement or premature opening of the bid.

#### **D. Submission and Opening of Bids**

##### **21. Deadline for Submission of Bids**

Bids must be received by the Procuring Entity's BAC at the address and on or before the date and time indicated in the **BDS**.

##### **22. Late Bids**

Any bid submitted after the deadline for submission and receipt of bids prescribed by the Procuring Entity, pursuant to **ITB** Clause 21, shall be declared "Late" and shall not be accepted by the Procuring Entity.

##### **23. Modification and Withdrawal of Bids**

- 23.1. The Bidder may modify its bid after it has been submitted; provided that the modification is received by the Procuring Entity prior to the deadline prescribed for submission and receipt of bids. The Bidder shall not be allowed to retrieve its original bid, but shall be allowed to submit another bid equally sealed, properly identified, linked to its original bid marked as "TECHNICAL MODIFICATION" or "FINANCIAL MODIFICATION" and stamped "received" by the BAC. Bid modifications received after the applicable deadline shall not be considered and shall be returned to the Bidder unopened.
- 23.2. A Bidder may, through a letter of withdrawal, withdraw its bid after it has been submitted, for valid and justifiable reason; provided that the letter of withdrawal is received by the Procuring Entity prior to the deadline prescribed for submission and receipt of bids.
- 23.3. Bids requested to be withdrawn in accordance with **ITB** Clause 23.1 shall be returned unopened to the Bidders. A Bidder may also express its intention not to participate in the bidding through a letter which should reach and be stamped by the BAC before the deadline for submission and receipt of bids. A Bidder that withdraws its bid shall not be permitted to submit another bid, directly or indirectly, for the same contract.
- 23.4. No bid may be modified after the deadline for submission of bids. No bid may be withdrawn in the interval between the deadline for submission of bids and the expiration of the period of bid validity specified by the Bidder on the Financial Bid Form. Withdrawal of a bid during this interval shall result in the forfeiture of the Bidder's bid security, pursuant to **ITB** Clause 18.5, and the imposition of administrative, civil, and criminal sanctions as prescribed by RA 9184 and its IRR.

##### **24. Opening and Preliminary Examination of Bids**

- 24.1. The BAC shall open the first bid envelopes of Bidders in public as specified in the **BDS** to determine each Bidder's compliance with the documents

prescribed in **ITB** Clause 12. For this purpose, the BAC shall check the submitted documents of each bidder against a checklist of required documents to ascertain if they are all present, using a non-discretionary “pass/fail” criterion. If a bidder submits the required document, it shall be rated “passed” for that particular requirement. In this regard, bids that fail to include any requirement or are incomplete or patently insufficient shall be considered as “failed”. Otherwise, the BAC shall rate the said first bid envelope as “passed”.

- 24.2. Immediately after determining compliance with the requirements in the first envelope, the BAC shall forthwith open the second bid envelope of each remaining eligible bidder whose first bid envelope was rated “passed”. The second envelope of each complying bidder shall be opened within the same day. In case one or more of the requirements in the second envelope of a particular bid is missing, incomplete or patently insufficient, and/or if the submitted total bid price exceeds the ABC unless otherwise provided in **ITB** Clause 13.2, the BAC shall rate the bid concerned as “failed”. Only bids that are determined to contain all the bid requirements for both components shall be rated “passed” and shall immediately be considered for evaluation and comparison.
- 24.3. Letters of withdrawal shall be read out and recorded during bid opening, and the envelope containing the corresponding withdrawn bid shall be returned to the Bidder unopened. If the withdrawing Bidder’s representative is in attendance, the original bid and all copies thereof shall be returned to the representative during the bid opening. If the representative is not in attendance, the Bid shall be returned unopened by registered mail. The Bidder may withdraw its bid prior to the deadline for the submission and receipt of bids, provided that the corresponding letter of withdrawal contains a valid authorization requesting for such withdrawal, subject to appropriate administrative sanctions.
- 24.4. If a Bidder has previously secured a certification from the Procuring Entity to the effect that it has previously submitted the above-enumerated Class “A” Documents, the said certification may be submitted in lieu of the requirements enumerated in **ITB** Clause 12.1(a), items (i) to (vi).
- 24.5. In the case of an eligible foreign Bidder as described in **ITB** Clause 5, the Class “A” Documents enumerated in **ITB** Clause 12.1(a) may be substituted with the appropriate equivalent documents, if any, issued by the country of the foreign Bidder concerned.
- 24.6. Each partner of a joint venture agreement shall likewise submit the documents required in **ITB** Clauses 12.1(a)(i) and 12.1(a)(ii). Submission of documents required under **ITB** Clauses 12.1(a)(iii) to 12.1(a)(vi) by any of the joint venture partners constitutes compliance.
- 24.7. A Bidder determined as “failed” has three (3) calendar days upon written notice or, if present at the time of bid opening, upon verbal notification within which to file a request for reconsideration with the BAC: Provided, however, that the request for reconsideration shall not be granted if it is established that the finding of failure is due to the fault of the Bidder concerned: Provided,

further, that the BAC shall decide on the request for reconsideration within seven (7) calendar days from receipt thereof. If a failed Bidder signifies his intent to file a request for reconsideration, the BAC shall keep the bid envelopes of the said failed Bidder unopened and/or duly sealed until such time that the request for reconsideration or protest has been resolved.

## **E. Evaluation and Comparison of Bids**

### **25. Process to be Confidential**

- 25.1. Members of the BAC, including its staff and personnel, as well as its Secretariat and TWG, are prohibited from making or accepting any kind of communication with any bidder regarding the evaluation of their bids until the issuance of the Notice of Award, unless otherwise allowed in the **BDS** or in the case of **ITB** Clause 26.
- 25.2. Any effort by a bidder to influence the Procuring Entity in the Procuring Entity's decision in respect of Bid evaluation, Bid comparison or contract award will result in the rejection of the Bidder's Bid.

### **26. Clarification of Bids**

To assist in the evaluation, comparison and post-qualification of the bids, the Procuring Entity may ask in writing any Bidder for a clarification of its bid. All responses to requests for clarification shall be in writing. Any clarification submitted by a Bidder in respect to its bid and that is not in response to a request by the Procuring Entity shall not be considered

### **27. Detailed Evaluation and Comparison of Bids**

- 27.1. The Procuring Entity will undertake the detailed evaluation and comparison of Bids which have passed the opening and preliminary examination of Bids, pursuant to **ITB** Clause 24, in order to determine the Lowest Calculated Bid.
- 27.2. In evaluating the Bids to get the Lowest Calculated Bid, the Procuring Entity shall undertake the following:
  - (a) The detailed evaluation of the financial component of the bids, to establish the correct calculated prices of the bids; and
  - (b) The ranking of the total bid prices as so calculated from the lowest to highest. The bid with the lowest price shall be identified as the Lowest Calculated Bid.
- 27.3. The Procuring Entity's BAC shall immediately conduct a detailed evaluation of all bids rated "passed," using non-discretionary "pass/fail" criterion. Unless otherwise specified in the **BDS**, the BAC shall consider the following in the evaluation of bids:
  - (a) Completeness of the bid. Unless the ITB specifically allows partial bids, bids not addressing or providing all of the required items in the

Schedule of Requirements including, where applicable, bill of quantities, shall be considered non-responsive and, thus, automatically disqualified. In this regard, where a required item is provided, but no price is indicated, the same shall be considered as non-responsive, but specifying a "0" (zero) for the said item would mean that it is being offered for free to the Procuring Entity; and

- (b) Arithmetical corrections. Consider computational errors, omissions, and other bid modifications, if allowed in the **BDS**, to enable proper comparison of all eligible bids. Any adjustment shall be calculated in monetary terms to determine the calculated prices.
- 27.4. Based on the detailed evaluation of bids, those that comply with the above-mentioned requirements shall be ranked in the ascending order of their total calculated bid prices, as evaluated and corrected for computational errors, discounts and other modifications, to identify the Lowest Calculated Bid. Total calculated bid prices, as evaluated and corrected for computational errors, discounts and other modifications, which exceed the ABC shall not be considered.
- 27.5. Unless otherwise indicated in the **BDS**, the Procuring Entity's evaluation of bids shall only be based on the bid price quoted in the Financial Bid Form
- 27.6. Bids shall be evaluated on an equal footing to ensure fair competition. For this purpose, all bidders shall be required to include in their bids the cost of all taxes, such as, but not limited to, value added tax (VAT), income tax, local taxes, and other fiscal levies and duties which shall be itemized in the bid form and reflected in the detailed estimates. Such bids, including said taxes, shall be the basis for bid evaluation and comparison.

## **28. Post Qualification**

- 28.1. The Procuring Entity shall determine to its satisfaction whether the Bidder that is evaluated as having submitted the Lowest Calculated Bid (LCB) complies with and is responsive to all the requirements and conditions specified in **ITB** Clauses 5, 12, and 13.
- 28.2. Within a non-extendible period of three (3) calendar days from receipt by the Bidder of the notice from the BAC that it submitted the LCB, the Bidder shall submit the following documentary requirements:
  - (a) Tax clearance per Executive Order 398, Series of 2005;
  - (b) Latest income and business tax returns in the form specified in the **BDS**;
  - (c) Certificate of PhilGEPS Registration; and
  - (d) Other appropriate licenses and permits required by law and stated in the **BDS**.



Failure of the Bidder declared as LCB to duly submit the requirements under this Clause or a finding against the veracity of such, shall be ground for forfeiture of the bid security and disqualification of the Bidder for award.

- 28.3. The determination shall be based upon an examination of the documentary evidence of the Bidder's qualifications submitted pursuant to **ITB** Clauses 12 and 13, as well as other information as the Procuring Entity deems necessary and appropriate, using a non-discretionary "pass/fail" criterion.
- 28.4. If the BAC determines that the Bidder with the Lowest Calculated Bid passes all the criteria for post-qualification, it shall declare the said bid as the Lowest Calculated Responsive Bid, and recommend to the Head of the Procuring Entity the award of contract to the said Bidder at its submitted price or its calculated bid price, whichever is lower, subject to **ITB** Clause 30.3.
- 28.5. A negative determination shall result in rejection of the Bidder's Bid, in which event the Procuring Entity shall proceed to the next Lowest Calculated Bid to make a similar determination of that Bidder's capabilities to perform satisfactorily. If the second Bidder, however, fails the post qualification, the procedure for post qualification shall be repeated for the Bidder with the next Lowest Calculated Bid, and so on until the Lowest Calculated and Responsive Bid is determined for contract award.
- 28.6. Within a period not exceeding seven (7) calendar days from the date of receipt of the recommendation of the BAC, the Head of the Procuring Entity shall approve or disapprove the said recommendation. In the case of government owned and government-owned and/or -controlled corporations (GOCCs) and government financial institutions (GFIs), the period provided herein shall be fifteen (15) calendar days.

## **29. Reservation Clause**

- 29.1. Notwithstanding the eligibility or post-qualification of a bidder, the Procuring Entity concerned reserves the right to review its qualifications at any stage of the procurement process if it has reasonable grounds to believe that a misrepresentation has been made by the said bidder, or that there has been a change in the Bidder's capability to undertake the project from the time it submitted its eligibility requirements. Should such review uncover any misrepresentation made in the eligibility and bidding requirements, statements or documents, or any changes in the situation of the Bidder which will affect its capability to undertake the project so that it fails the preset eligibility or bid evaluation criteria, the Procuring Entity shall consider the said Bidder as ineligible and shall disqualify it from submitting a bid or from obtaining an award or contract.
- 29.2. Based on the following grounds, the Procuring Entity reserves the right to reject any and all Bids, declare a Failure of Bidding at any time prior to the contract award, or not to award the contract, without thereby incurring any liability, and make no assurance that a contract shall be entered into as a result of the bidding:

- (a) if there is *prima facie* evidence of collusion between appropriate public officers or employees of the Procuring Entity, or between the BAC and any of the bidders, or if the collusion is between or among the bidders themselves, or between a bidder and a third party, including any act which restricts, suppresses or nullifies or tends to restrict, suppress or nullify competition;
- (b) if the Procuring Entity's BAC is found to have failed in following the prescribed bidding procedures; or
- (c) for any justifiable and reasonable ground where the award of the contract will not redound to the benefit of the Government as follows:
  - (i) If the physical and economic conditions have significantly changed so as to render the project no longer economically, financially or technically feasible as determined by the head of the procuring entity;
  - (ii) If the project is no longer necessary as determined by the head of the procuring entity; and
  - (iii) If the source of funds for the project has been withheld or reduced through no fault of the Procuring Entity.

29.3. In addition, the Procuring Entity may likewise declare a failure of bidding when:

- (a) No bids are received;
- (b) All prospective bidders are declared ineligible;
- (c) All bids fail to comply with all the bid requirements or fail post-qualification; or
- (d) The bidder with the Lowest Calculated Responsive Bid refuses, without justifiable cause to accept the award of contract, and no award is made.

## **F. Award of Contract**

### **30. Contract Award**

- 30.1. Subject to **ITB** Clause 28, the Procuring Entity shall award the contract to the Bidder whose Bid has been determined to be the Lowest Calculated and Responsive Bid (LCRB).
- 30.2. Prior to the expiration of the period of Bid validity, the Procuring Entity shall notify the successful Bidder in writing that its Bid has been accepted, through a Notice of Award received personally or sent by registered mail or electronically, receipt of which must be confirmed in writing within two (2) days by the LCRB and submitted personally or sent by registered mail or electronically to the Procuring Entity.

- 30.3. Notwithstanding the issuance of the Notice of Award, award of contract shall be subject to the following conditions:
- (a) Submission of the following documents within the prescribed period from receipt by the Bidder of the notice that it has the Lowest Calculated and Responsive Bid:
    - (i) Valid JVA, if applicable, within ten (10) calendar days;
    - (ii) Valid PCAB license and registration for the type and cost of the contract to be bid for foreign bidders, within thirty (30) calendar days, if allowed under a Treaty or International or Executive Agreement mentioned in **ITB** Clause 12.1(a)(iv);
  - (b) Posting of the performance security in accordance with **ITB** Clause 32;
  - (c) Signing of the contract as provided in **ITB** Clause 31; and
  - (d) Approval by higher authority, if required.

### **31. Signing of the Contract**

- 31.1. At the same time as the Procuring Entity notifies the successful Bidder that its Bid has been accepted, the Procuring Entity shall send the Contract Form to the Bidder, which Contract has been provided in the Bidding Documents, incorporating therein all agreements between the parties.
- 31.2. Within ten (10) calendar days from receipt of the Notice of Award, the successful Bidder shall post the required performance security, sign and date the contract and return it to the Procuring Entity.
- 31.3. The Procuring Entity shall enter into contract with the successful Bidder within the same ten (10) calendar day period provided that all the documentary requirements are complied with.
- 31.4. The following documents shall form part of the contract:
- (a) Contract Agreement;
  - (b) Bidding Documents;
  - (c) Winning bidder's bid, including the Technical and Financial Proposals, and all other documents/statements submitted;
  - (d) Performance Security;
  - (e) Credit line in accordance with **ITB** Clause 5.5, if applicable;
  - (f) Notice of Award of Contract; and
  - (g) Other contract documents that may be required by existing laws and/or specified in the **BDS**.

### 32. Performance Security

- 32.1. To guarantee the faithful performance by the winning Bidder of its obligations under the contract, it shall post a performance security within a maximum period of ten (10) calendar days from the receipt of the Notice of Award from the Procuring Entity and in no case later than the signing of the contract.
- 32.2. The performance security shall be denominated in Philippine Pesos and posted in favor of the Procuring Entity in an amount equal to the percentage of the total contract price in accordance with the following schedule:

Form of Performance Security	Amount of Performance Security (Equal to Percentage of the Total Contract Price)
(a) Cash or cashier's/manager's check issued by a Universal or Commercial Bank.	Ten percent (10%)
(b) Bank draft/guarantee or irrevocable letter of credit issued by a Universal or Commercial Bank: Provided, however, that it shall be confirmed or authenticated by a Universal or Commercial Bank, if issued by a foreign bank.	
(c) Surety bond callable upon demand issued by a surety or insurance company duly certified by the Insurance Commission as authorized to issue such security; and/or	Thirty percent (30%)
(d) Any combination of the foregoing.	Proportionate to share of form with respect to total amount of security

- 32.3. Failure of the successful Bidder to comply with the above-mentioned requirement shall constitute sufficient ground for the annulment of the award and forfeiture of the bid security, in which event the Procuring Entity shall initiate and complete the post qualification of the second Lowest Calculated Bid. The procedure shall be repeated until the Lowest Calculated and Responsive Bid is identified and selected for contract award. However if no Bidder passed post-qualification, the BAC shall declare the bidding a failure and conduct a re-bidding with re-advertisement.

### 33. Notice to Proceed

- 33.1. Within three (3) calendar days from the date of approval of the Contract by the appropriate government approving authority, the Procuring Entity shall issue its Notice to Proceed to the Bidder.

33.2. The date of the Bidder's receipt of the Notice to Proceed will be regarded as the effective date of the Contract, unless otherwise specified in the **BDS**.

### Section III. Bid Data Sheet

ITB Clause	
1.1	The Procuring Entity is the Department of Budget and Management.
1.2	This bidding shall have one (1) lot as follows:  <b>“Roofing with Catwalk Structural”</b>
2	The Funding Source is:  The Government of the Philippines (GOP) through the authorized appropriations under the FY 2014 General Appropriations Act in the amount of <b>Three Million Seven Hundred Twelve Thousand Pesos (P3,712,000.00)</b> .  The name of the Project is <b>“Roofing with Catwalk Structural”</b>
3.1	No further instructions.
5.1	No further instructions.
5.2	Bidding is restricted to eligible bidders as defined in ITB Clause 5.1.
5.4	The bidder must have completed, ten (10) years prior to pre-bid conference, a single contract that is similar to the Project at hand and whose value must be at least fifty percent (50%) of the ABC to bid. Such contract must be part of, or included in, the Statement under Item 12.1(a)(iii) hereof.  Bidders shall include in their bids a photocopy of their Single Largest Completed Contract supported by the (i) Constructors Performance Evaluation System (CPES) rating sheet which must have a satisfactory rating; or (ii) certificate of satisfactory completion of the project.  Failure to submit the above requirements or failure against the veracity of such shall be a ground for disqualification of the bidder for award and forfeiture of the bid security.  For this purpose, similar contract shall refer to services with general works.
7	No further instructions.
8.1	Subcontracting is allowed.
8.2	Not applicable.
9.1	The Procuring Entity will hold a pre-bid conference for this Project on May14, 2014, 11:00 a.m., BAC Room, Ground Floor, DBM Building III, General Solano St., San Miguel, Manila.
10.1	The Procuring Entity’s address is: Department of Budget and Management DBM Bldg. III, General Solano St. San Miguel, Manila

12.1(a)	<p>The first envelope shall contain the eligibility and technical documents stated in the <b>ITB</b> Clause. In addition, the following shall be submitted and included in the first envelope:</p> <ul style="list-style-type: none"> <li>a. Single Largest Contract i.e., similar contract completed within ten (10) years from May 14, 2014, whose value must be at least (50%) fifty percent of the ABC supported by the Constructors Performance Evaluation System (CPES) rating sheet which must have a satisfactory rating or a certificate of satisfactory completion of the project, as the case may be;</li> <li>b. Statement of Availability of Key Personnel and Equipment (<b>See sample form under Section IX. Bidding and Sample Forms</b>);</li> <li>c. Proof of authority of the authorized representative to enter into this Project, as the case may be, to wit: <ul style="list-style-type: none"> <li>5.1 Sole proprietorship – Sworn Affidavit of the proprietor or a Special Power of Attorney;</li> <li>5.2 Partnership – Notarized Partnership Resolution from the President or General Manager;</li> <li>5.3 Corporation – Notarized Secretary’s Certificate of Board Resolution;</li> <li>5.4 Joint Venture – Notarized Resolution by each Joint Venture Member; and</li> </ul> </li> <li>d. Notarized Affidavit of Site Inspection (<b>See sample form under Section IX. Bidding and Sample Forms</b>).</li> </ul>
12.1(a)(i)	<p>For corporations/partnerships, the following may also be submitted: latest articles of incorporation partnerships by laws or amendments thereto, duly approved by the Securities and Exchange Commission.</p>
12.1(a)(iii)	<p>The statement of all ongoing and completed government and private contracts shall include such contract within ten (10) years prior to May14,2014.</p>
12.1(a)(iv)	<p>In accordance with Philippine Contractors Accreditation Board Circular No.001, series of 2009, the required license category for this Project is at least license category C &amp; D or size range Small B.</p>
12.1(b)(ii.2)	<p>The list of contractor’s personnel to be assigned to the Contract must be supported by their respective resumes and photocopy of Professional Regulation Commission (PRC) license, if applicable. <b>See sample form of the list under Section IX. Bidding and Sample Forms.</b></p>

12.1(b)(ii.3)	<p>The list of contractor's equipment must be supported by proof of ownership, lease and/or purchase agreements. For lease and purchase agreements, such proof must include a certification of availability of equipment from the lessor/vendor for the duration of the project. The Bidder may provide additional equipment to the minimum requirements as it may deem necessary for the works. <b>See sample form of the list under Section IX. Bidding and Sample Forms.</b></p> <p>The minimum required equipment to be provided by the contractor are the following:</p> <ul style="list-style-type: none"> <li>(i) 2 units 300 Amp welding machine</li> <li>(ii) 2 units electric grinders</li> <li>(iii) 6 units electric drills</li> </ul>
12.1(b) (iii)	<p>Notarization of this document shall comply with the 2004 Rules on Notarial Practice which limits competent evidence of identity to the following:</p> <p>(i) identification documents issued by an official agency bearing the photograph and signature of the individual i.e., passport, driver's license, SSS ID, GSIS e-card, etc.; and (ii) the oath of affirmation of one credible witness not privy to the instrument, document or transaction who is personally known to the notary public and who personally knows the individual and shows to the notary public documentary identification.</p>
13.1	<p>The financial component of the Bid shall be contained in the second envelope. In addition, a duly accomplished Bill of Quantities and its Detailed Estimates, signed by the bidder's authorized representative, shall be submitted and included in the second envelope. The Detailed Estimates shall include (a) a summary sheet indicating the unit prices of construction materials, labor rates and equipment rentals used in coming up with the bid and (b) the mobilization cost including the cost for the construction safety and health program for the project.</p> <p>The bidders, in formulating their bid prices, should take into consideration the items of works in the Bill of Quantities and the relevant details and specifications in the Drawings and Building Specifications.</p>
13.2	<p>The ABC is <b>Three Million Seven Hundred Twelve Thousand Pesos (P3,712,000.00)</b>. Any bid with a financial component exceeding this amount shall not be accepted.</p>
15.4(a)(iii)	<p>No incidental services are required.</p>
15.4(b)	<p>Not applicable.</p>
16.3	<p>The Bid Prices for Goods supplied from outside of the Philippines shall be quoted in Philippine Pesos.</p>
17.1	<p>Bids shall be valid until September 24, 2014.</p>



18.1	<p>The bid security issued in favor of the DBM shall be either in the following forms and amount:</p> <p>a) 2% of the ABC or P74,240.00, if bid security is in cash, cashier's/manager's check, bank draft/guarantee or irrevocable letter of credit;</p> <p>b) 5% of the ABC or P185,600.00, if bid security is in Surety Bond accompanied with a certification from the Insurance Commission that insurance company is authorized to insure such security;</p> <p>c) Any combination of the foregoing proportionate to the share of form with respect to total amount of security; or</p> <p>d) Bid Securing Declaration in accordance with the Guidelines on the Use of Bid Securing Declaration issued through GPPB Resolution No. 03-2012 dated January 27, 2012.</p>
18.2	The bid security shall be valid until September 24, 2014.
20.3	Each Bidder shall submit one (1) original and two (2) duplicate copies of the first and second components of its bid.
21	<p>The address for submission of bids is BAC Room, Ground Floor, DBM Building III, General Solano St., San Miguel, Manila.</p> <p>The deadline for submission of bids is May 27, 2014, 11:00 a.m. Late bids shall not be accepted.</p>
24.1	<p>The place of bid opening is BAC Room, Ground Floor, DBM Building III, General Solano St., San Miguel, Manila.</p> <p>The date and time of bid opening is May 27, 2014, 11:00 a.m.</p>
24.2	No further instructions.
27.1	No further instructions.
28.2(b)	<p>Latest Income and Business Tax Returns, filed and paid through the Electronic Filing and Payments System (EFPS), consisting of the following:</p> <ul style="list-style-type: none"> <li>- 2013 Income Tax Return with proof of payment</li> <li>- VAT Returns (Form 2550M and 2550Q) or Percentage Tax Returns (2551M) with proof of payment covering the months from November 2013 to April 2014.</li> </ul>
28.4	No further instructions.
31.4(g)	<p>The following documents shall be submitted by the winning bidder within fifteen (15) calendar days from receipt of the Notice of Award:</p> <ol style="list-style-type: none"> <li>1.) Construction schedule and S-curve;</li> <li>2.) Manpower schedule;</li> <li>3.) Construction methods;</li> <li>4.) Equipment utilization schedule;</li> <li>5.) Construction safety and health program approved by the Department of Labor and Employment;</li> <li>6.) Program evaluation and review technique/critical path method;</li> </ol> <p>Note: The foregoing documents are subject to approval of the Procuring Entity or his duly authorized representative and may thus be changed.</p>

32.2	<p>The performance security shall be in the following amount:</p> <ol style="list-style-type: none"><li data-bbox="446 220 1385 325">1. The amount of 10% of the total contract price if performance security is in cash, cashier's/manager's check, bank draft/guarantee or irrevocable letter of credit;</li><li data-bbox="446 325 1385 388">2. The amount of 30% of the total contract price if performance security is in Surety Bond; or</li></ol> <p>Any combination of the foregoing proportionate to the share of form with respect to total amount of security.</p>
------	---

## Section IV. General Conditions of Contract

### TABLE OF CONTENTS

1. DEFINITIONS .....	37
2. INTERPRETATION .....	39
3. GOVERNING LANGUAGE AND LAW .....	39
4. COMMUNICATIONS .....	39
5. POSSESSION OF SITE .....	40
6. THE CONTRACTOR'S OBLIGATIONS .....	40
7. PERFORMANCE SECURITY .....	41
8. SUBCONTRACTING .....	42
9. LIQUIDATED DAMAGES .....	42
10. SITE INVESTIGATION REPORTS.....	43
11. THE PROCURING ENTITY, LICENSES AND PERMITS.....	43
12. CONTRACTOR'S RISK AND WARRANTY SECURITY .....	43
13. LIABILITY OF THE CONTRACTOR .....	45
14. PROCURING ENTITY'S RISK.....	45
15. INSURANCE .....	46
16. TERMINATION FOR DEFAULT OF CONTRACTOR .....	47
17. TERMINATION FOR DEFAULT OF PROCURING ENTITY .....	48
18. TERMINATION FOR OTHER CAUSES .....	48
19. PROCEDURES FOR TERMINATION OF CONTRACTS.....	50
20. FORCE MAJEURE, RELEASE FROM PERFORMANCE .....	52
21. RESOLUTION OF DISPUTES.....	53
22. SUSPENSION OF LOAN, CREDIT, GRANT, OR APPROPRIATION .....	53
23. PROCURING ENTITY'S REPRESENTATIVE'S DECISIONS.....	54
24. APPROVAL OF DRAWINGS AND TEMPORARY WORKS BY THE PROCURING ENTITY'S REPRESENTATIVE.....	54
25. ACCELERATION AND DELAYS ORDERED BY THE PROCURING ENTITY'S REPRESENTATIVE .....	54
26. EXTENSION OF THE INTENDED COMPLETION DATE .....	54
27. RIGHT TO VARY.....	55

<b>28. CONTRACTORS RIGHT TO CLAIM.....</b>	<b>55</b>
<b>29. DAYWORKS .....</b>	<b>55</b>
<b>30. EARLY WARNING .....</b>	<b>55</b>
<b>31. PROGRAM OF WORK .....</b>	<b>56</b>
<b>32. MANAGEMENT CONFERENCES.....</b>	<b>56</b>
<b>33. BILL OF QUANTITIES .....</b>	<b>57</b>
<b>34. INSTRUCTIONS, INSPECTIONS AND AUDITS.....</b>	<b>57</b>
<b>35. IDENTIFYING DEFECTS .....</b>	<b>57</b>
<b>36. COST OF REPAIRS .....</b>	<b>58</b>
<b>37. CORRECTION OF DEFECTS .....</b>	<b>58</b>
<b>38. UNCORRECTED DEFECTS .....</b>	<b>58</b>
<b>39. ADVANCE PAYMENT .....</b>	<b>58</b>
<b>40. PROGRESS PAYMENTS .....</b>	<b>59</b>
<b>41. PAYMENT CERTIFICATES .....</b>	<b>60</b>
<b>42. RETENTION .....</b>	<b>60</b>
<b>43. VARIATION ORDERS .....</b>	<b>61</b>
<b>44. CONTRACT COMPLETION.....</b>	<b>62</b>
<b>45. SUSPENSION OF WORK .....</b>	<b>62</b>
<b>46. PAYMENT ON TERMINATION .....</b>	<b>63</b>
<b>47. EXTENSION OF CONTRACT TIME .....</b>	<b>64</b>
<b>48. PRICE ADJUSTMENT .....</b>	<b>65</b>
<b>49. COMPLETION .....</b>	<b>65</b>
<b>50. TAKING OVER.....</b>	<b>65</b>
<b>51. OPERATING AND MAINTENANCE MANUALS.....</b>	<b>65</b>

## 1. Definitions

For purposes of this Clause, boldface type is used to identify defined terms.

- 1.1. The **Arbiter** is the person appointed jointly by the Procuring Entity and the Contractor to resolve disputes in the first instance, as provided for in **GCC** Clause 21.
- 1.2. **Bill of Quantities** refers to a list of the specific items of the Work and their corresponding unit prices, lump sums, and/or provisional sums.
- 1.3. The **Completion Date** is the date of completion of the Works as certified by the Procuring Entity's Representative, in accordance with **GCC** Clause 49.
- 1.4. The **Contract** is the contract between the Procuring Entity and the Contractor to execute, complete, and maintain the Works.
- 1.5. The **Contract Price** is the price stated in the Letter of Acceptance and thereafter to be paid by the Procuring Entity to the Contractor for the execution of the Works in accordance with this Contract.
- 1.6. **Contract Time Extension** is the allowable period for the Contractor to complete the Works in addition to the original Completion Date stated in this Contract.
- 1.7. The **Contractor** is the juridical entity whose proposal has been accepted by the Procuring Entity and to whom the Contract to execute the Work was awarded.
- 1.8. The **Contractor's Bid** is the signed offer or proposal submitted by the Contractor to the Procuring Entity in response to the Bidding Documents.
- 1.9. **Days** are calendar days; months are calendar months.
- 1.10. **Dayworks** are varied work inputs subject to payment on a time basis for the Contractor's employees and Equipment, in addition to payments for associated Materials and Plant.
- 1.11. A **Defect** is any part of the Works not completed in accordance with the Contract.
- 1.12. The **Defects Liability Certificate** is the certificate issued by Procuring Entity's Representative upon correction of defects by the Contractor.
- 1.13. The **Defects Liability Period** is the one year period between project completion and final acceptance within which the Contractor assumes the responsibility to undertake the repair of any damage to the Works at his own expense.
- 1.14. **Drawings** are graphical presentations of the Works. They include all supplementary details, shop drawings, calculations, and other information provided or approved for the execution of this Contract.

- 1.15. **Equipment** refers to all facilities, supplies, appliances, materials or things required for the execution and completion of the Work provided by the Contractor and which shall not form or are not intended to form part of the Permanent Works.
- 1.16. The **Intended Completion Date** refers to the date specified in the **SCC** when the Contractor is expected to have completed the Works. The Intended Completion Date may be revised only by the Procuring Entity's Representative by issuing an extension of time or an acceleration order.
- 1.17. **Materials** are all supplies, including consumables, used by the Contractor for incorporation in the Works.
- 1.18. The **Notice to Proceed** is a written notice issued by the Procuring Entity or the Procuring Entity's Representative to the Contractor requiring the latter to begin the commencement of the work not later than a specified or determinable date.
- 1.19. **Permanent Works** all permanent structures and all other project features and facilities required to be constructed and completed in accordance with this Contract which shall be delivered to the Procuring Entity and which shall remain at the Site after the removal of all Temporary Works.
- 1.20. **Plant** refers to the machinery, apparatus, and the like intended to form an integral part of the Permanent Works.
- 1.21. The **Procuring Entity** is the party who employs the Contractor to carry out the Works stated in the **SCC**.
- 1.22. The **Procuring Entity's Representative** refers to the Head of the Procuring Entity or his duly authorized representative, identified in the **SCC**, who shall be responsible for supervising the execution of the Works and administering this Contract.
- 1.23. The **Site** is the place provided by the Procuring Entity where the Works shall be executed and any other place or places which may be designated in the **SCC**, or notified to the Contractor by the Procuring Entity's Representative as forming part of the Site.
- 1.24. **Site Investigation Reports** are those that were included in the Bidding Documents and are factual and interpretative reports about the surface and subsurface conditions at the Site.
- 1.25. **Slippage** is a delay in work execution occurring when actual accomplishment falls below the target as measured by the difference between the scheduled and actual accomplishment of the Work by the Contractor as established from the work schedule. This is actually described as a percentage of the whole Works.
- 1.26. **Specifications** means the description of Works to be done and the qualities of materials to be used, the equipment to be installed and the mode of construction.

- 1.27. The **Start Date**, as specified in the **SCC**, is the date when the Contractor is obliged to commence execution of the Works. It does not necessarily coincide with any of the Site Possession Dates.
- 1.28. A **Subcontractor** is any person or organization to whom a part of the Works has been subcontracted by the Contractor, as allowed by the Procuring Entity, but not any assignee of such person.
- 1.29. **Temporary Works** are works designed, constructed, installed, and removed by the Contractor that are needed for construction or installation of the Permanent Works.
- 1.30. **Work(s)** refer to the Permanent Works and Temporary Works to be executed by the Contractor in accordance with this Contract, including (i) the furnishing of all labor, materials, equipment and others incidental, necessary or convenient to the complete execution of the Works; (ii) the passing of any tests before acceptance by the Procuring Entity's Representative; (iii) and the carrying out of all duties and obligations of the Contractor imposed by this Contract as described in the **SCC**.

## **2. Interpretation**

- 2.1. In interpreting the Conditions of Contract, singular also means plural, male also means female or neuter, and the other way around. Headings have no significance. Words have their normal meaning under the language of this Contract unless specifically defined. The Procuring Entity's Representative will provide instructions clarifying queries about the Conditions of Contract.
- 2.2. If sectional completion is specified in the **SCC**, references in the Conditions of Contract to the Works, the Completion Date, and the Intended Completion Date apply to any Section of the Works (other than references to the Completion Date and Intended Completion Date for the whole of the Works).

## **3. Governing Language and Law**

- 3.1. This Contract has been executed in the English language, which shall be the binding and controlling language for all matters relating to the meaning or interpretation of this Contract. All correspondence and other documents pertaining to this Contract which are exchanged by the parties shall be written in English.
- 3.2. This Contract shall be interpreted in accordance with the laws of the Republic of the Philippines.

## **4. Communications**

Communications between parties that are referred to in the Conditions shall be effective only when in writing. A notice shall be effective only when it is received by the concerned party.

## **5. Possession of Site**

- 5.1. On the date specified in the SCC, the Procuring Entity shall grant the Contractor possession of so much of the Site as may be required to enable it to proceed with the execution of the Works. If the Contractor suffers delay or incurs cost from failure on the part of the Procuring Entity to give possession in accordance with the terms of this clause, the Procuring Entity's Representative shall give the Contractor a Contract Time Extension and certify such sum as fair to cover the cost incurred, which sum shall be paid by Procuring Entity.
- 5.2. If possession of a portion is not given by the date stated in the SCC Clause 5.1, the Procuring Entity will be deemed to have delayed the start of the relevant activities. The resulting adjustments in contract time to address such delay shall be in accordance with GCC Clause 47.
- 5.3. The Contractor shall bear all costs and charges for special or temporary right-of-way required by it in connection with access to the Site. The Contractor shall also provide at his own cost any additional facilities outside the Site required by it for purposes of the Works.
- 5.4. The Contractor shall allow the Procuring Entity's Representative and any person authorized by the Procuring Entity's Representative access to the Site and to any place where work in connection with this Contract is being carried out or is intended to be carried out.

## **6. The Contractor's Obligations**

- 6.1. The Contractor shall carry out the Works properly and in accordance with this Contract. The Contractor shall provide all supervision, labor, Materials, Plant and Contractor's Equipment, which may be required. All Materials and Plant on Site shall be deemed to be the property of the Procuring Entity.
- 6.2. The Contractor shall commence execution of the Works on the Start Date and shall carry out the Works in accordance with the Program of Work submitted by the Contractor, as updated with the approval of the Procuring Entity's Representative, and complete them by the Intended Completion Date.
- 6.3. The Contractor shall be responsible for the safety of all activities on the Site.
- 6.4. The Contractor shall carry out all instructions of the Procuring Entity's Representative that comply with the applicable laws where the Site is located.
- 6.5. The Contractor shall employ the key personnel named in the Schedule of Key Personnel, as referred to in the SCC, to carry out the supervision of the Works. The Procuring Entity will approve any proposed replacement of key personnel only if their relevant qualifications and abilities are equal to or better than those of the personnel listed in the Schedule.
- 6.6. If the Procuring Entity's Representative asks the Contractor to remove a member of the Contractor's staff or work force, for justifiable cause, the



Contractor shall ensure that the person leaves the Site within seven (7) days and has no further connection with the Work in this Contract.

- 6.7. During Contract implementation, the Contractor and his subcontractors shall abide at all times by all labor laws, including child labor related enactments, and other relevant rules.
- 6.8. The Contractor shall submit to the Procuring Entity for consent the name and particulars of the person authorized to receive instructions on behalf of the Contractor.
- 6.9. The Contractor shall cooperate and share the Site with other contractors, public authorities, utilities, and the Procuring Entity between the dates given in the schedule of other contractors particularly when they shall require access to the Site. The Contractor shall also provide facilities and services for them during this period. The Procuring Entity may modify the schedule of other contractors, and shall notify the Contractor of any such modification thereto.
- 6.10. Should anything of historical or other interest or of significant value be unexpectedly discovered on the Site, it shall be the property of the Procuring Entity. The Contractor shall notify the Procuring Entity's Representative of such discoveries and carry out the Procuring Entity's Representative's instructions in dealing with them.

## **7. Performance Security**

- 7.1. Unless otherwise specified in the **SCC**, within ten (10) calendar days from receipt of the Notice of Award from the Procuring Entity but in no case later than the signing of the contract by both parties, the Contractor shall furnish the performance security in any the forms prescribed in **ITB** Clause 32.2.
- 7.2. The performance security posted in favor of the Procuring Entity shall be forfeited in the event it is established that the Contractor is in default in any of its obligations under the Contract.
- 7.3. The performance security shall remain valid until issuance by the Procuring Entity of the Certificate of Final Acceptance.
- 7.4. The performance security may be released by the Procuring Entity and returned to the Contractor after the issuance of the Certificate of Final Acceptance subject to the following conditions:
  - (a) There are no pending claims against the Contractor or the surety company filed by the Procuring Entity;
  - (b) The Contractor has no pending claims for labor and materials filed against it; and
  - (c) Other terms specified in the **SCC**.
- 7.5. The Contractor shall post an additional performance security following the amount and form specified in **ITB** Clause 32.2 to cover any cumulative

increase of more than ten percent (10%) over the original value of the contract as a result of amendments to order or change orders, extra work orders and supplemental agreements, as the case may be. The Contractor shall cause the extension of the validity of the performance security to cover approved contract time extensions.

- 7.6. In case of a reduction in the contract value or for partially completed Works under the contract which are usable and accepted by the Procuring Entity the use of which, in the judgment of the implementing agency or the Procuring Entity, will not affect the structural integrity of the entire project, the Procuring Entity shall allow a proportional reduction in the original performance security, provided that any such reduction is more than ten percent (10%) and that the aggregate of such reductions is not more than fifty percent (50%) of the original performance security.
- 7.7. The Contractor, by entering into the Contract with the Procuring Entity, acknowledges the right of the Procuring Entity to institute action pursuant to Act 3688 against any subcontractor be they an individual, firm, partnership, corporation, or association supplying the Contractor with labor, materials and/or equipment for the performance of this Contract.

## **8. Subcontracting**

- 8.1. Unless otherwise indicated in the **SCC**, the Contractor cannot subcontract Works more than the percentage specified in **ITB** Clause 8.1.
- 8.2. Subcontracting of any portion of the Works does not relieve the Contractor of any liability or obligation under this Contract. The Contractor will be responsible for the acts, defaults, and negligence of any subcontractor, its agents, servants or workmen as fully as if these were the Contractor's own acts, defaults, or negligence, or those of its agents, servants or workmen.
- 8.3. Subcontractors disclosed and identified during the bidding may be changed during the implementation of this Contract, subject to compliance with the required qualifications and the approval of the Procuring Entity.

## **9. Liquidated Damages**

- 9.1. The Contractor shall pay liquidated damages to the Procuring Entity at the rate per day stated in the **SCC** for each day that the Completion Date is later than the Intended Completion Date. The total amount of liquidated damages shall not exceed the amount defined in the **SCC**. The Procuring Entity may deduct liquidated damages from payments due to the Contractor. Payment of liquidated damages shall not affect the Contractor. Once the cumulative amount of liquidated damages reaches ten percent (10%) of the amount of this Contract, the Procuring Entity shall rescind this Contract, without prejudice to other courses of action and remedies open to it.
- 9.2. If the Intended Completion Date is extended after liquidated damages have been paid, the Engineer of the Procuring Entity shall correct any overpayment of liquidated damages by the Contractor by adjusting the next payment

certificate. The Contractor shall be paid interest on the overpayment, calculated from the date of payment to the date of repayment, at the rates specified in GCC Clause 40.1.

## **10. Site Investigation Reports**

The Contractor, in preparing the Bid, shall rely on any Site Investigation Reports referred to in the SCC supplemented by any information obtained by the Contractor.

## **11. The Procuring Entity, Licenses and Permits**

The Procuring Entity shall, if requested by the Contractor, assist him in applying for permits, licenses or approvals, which are required for the Works.

## **12. Contractor's Risk and Warranty Security**

12.1. The Contractor shall assume full responsibility for the Works from the time project construction commenced up to final acceptance by the Procuring Entity and shall be held responsible for any damage or destruction of the Works except those occasioned by *force majeure*. The Contractor shall be fully responsible for the safety, protection, security, and convenience of his personnel, third parties, and the public at large, as well as the Works, Equipment, installation, and the like to be affected by his construction work.

12.2. The defects liability period for infrastructure projects shall be one year from project completion up to final acceptance by the Procuring Entity. During this period, the Contractor shall undertake the repair works, at his own expense, of any damage to the Works on account of the use of materials of inferior quality within ninety (90) days from the time the Head of the Procuring Entity has issued an order to undertake repair. In case of failure or refusal to comply with this mandate, the Procuring Entity shall undertake such repair works and shall be entitled to full reimbursement of expenses incurred therein upon demand.

12.3. In case the Contractor fails to comply with the preceding paragraph, the Procuring Entity shall forfeit its performance security, subject its property (ies) to attachment or garnishment proceedings, and perpetually disqualify it from participating in any public bidding. All payables of the GOP in his favor shall be offset to recover the costs.

12.4. After final acceptance of the Works by the Procuring Entity, the Contractor shall be held responsible for "Structural Defects", *i.e.*, major faults/flaws/deficiencies in one or more key structural elements of the project which may lead to structural failure of the completed elements or structure, or "Structural Failures", *i.e.*, where one or more key structural elements in an infrastructure facility fails or collapses, thereby rendering the facility or part thereof incapable of withstanding the design loads, and/or endangering the safety of the users or the general public:

(a) Contractor – Where Structural Defects/Failures arise due to faults attributable to improper construction, use of inferior

quality/substandard materials, and any violation of the contract plans and specifications, the contractor shall be held liable;

- (b) Consultants – Where Structural Defects/Failures arise due to faulty and/or inadequate design and specifications as well as construction supervision, then the consultant who prepared the design or undertook construction supervision for the project shall be held liable;
- (c) Procuring Entity’s Representatives/Project Manager/Construction Managers and Supervisors – The project owner’s representative(s), project manager, construction manager, and supervisor(s) shall be held liable in cases where the Structural Defects/Failures are due to his/their willful intervention in altering the designs and other specifications; negligence or omission in not approving or acting on proposed changes to noted defects or deficiencies in the design and/or specifications; and the use of substandard construction materials in the project;
- (d) Third Parties - Third Parties shall be held liable in cases where Structural Defects/Failures are caused by work undertaken by them such as leaking pipes, diggings or excavations, underground cables and electrical wires, underground tunnel, mining shaft and the like, in which case the applicable warranty to such structure should be levied to third parties for their construction or restoration works.
- (e) Users - In cases where Structural Defects/Failures are due to abuse/misuse by the end user of the constructed facility and/or non-compliance by a user with the technical design limits and/or intended purpose of the same, then the user concerned shall be held liable.

12.5. The warranty against Structural Defects/Failures, except those occasioned on force majeure, shall cover the period specified in the **SCC** reckoned from the date of issuance of the Certificate of Final Acceptance by the Procuring Entity.

12.6. The Contractor shall be required to put up a warranty security in the form of cash, bank guarantee, letter of credit, GSIS or surety bond callable on demand, in accordance with the following schedule:

Form of Warranty	Minimum Amount in Percentage (%) of Total Contract Price
(a) Cash or letter of credit issued by Universal or Commercial bank: provided, however, that the letter of credit shall be confirmed or authenticated by a Universal or Commercial bank, if issued by a foreign bank	Five Percent (5%)
(b) Bank guarantee confirmed by Universal or Commercial bank: provided, however, that the letter of credit shall be confirmed or	Ten Percent (10%)

authenticated by a Universal or Commercial bank, if issued by a foreign bank	
(c) Surety bond callable upon demand issued by GSIS or any surety or insurance company duly certified by the Insurance Commission	Thirty Percent (30%)

- 12.7. The warranty security shall be stated in Philippine Pesos and shall remain effective for one year from the date of issuance of the Certificate of Final Acceptance by the Procuring Entity, and returned only after the lapse of said one year period.
- 12.8. In case of structural defects/failure occurring during the applicable warranty period provided in **GCC** Clause 12.5, the Procuring Entity shall undertake the necessary restoration or reconstruction works and shall be entitled to full reimbursement by the parties found to be liable for expenses incurred therein upon demand, without prejudice to the filing of appropriate administrative, civil, and/or criminal charges against the responsible persons as well as the forfeiture of the warranty security posted in favor of the Procuring Entity.

### **13. Liability of the Contractor**

Subject to additional provisions, if any, set forth in the **SCC**, the Contractor's liability under this Contract shall be as provided by the laws of the Republic of the Philippines.

### **14. Procuring Entity's Risk**

- 14.1. From the Start Date until the Certificate of Final Acceptance has been issued, the following are risks of the Procuring Entity:
- (a) The risk of personal injury, death, or loss of or damage to property (excluding the Works, Plant, Materials, and Equipment), which are due to:
    - (i) any type of use or occupation of the Site authorized by the Procuring Entity after the official acceptance of the works; or
    - (ii) negligence, breach of statutory duty, or interference with any legal right by the Procuring Entity or by any person employed by or contracted to him except the Contractor.
  - (b) The risk of damage to the Works, Plant, Materials, and Equipment to the extent that it is due to a fault of the Procuring Entity or in the Procuring Entity's design, or due to war or radioactive contamination directly affecting the country where the Works are to be executed.

## 15. Insurance

- 15.1. The Contractor shall, under his name and at his own expense, obtain and maintain, for the duration of this Contract, the following insurance coverage:
- (a) Contractor's All Risk Insurance;
  - (b) Transportation to the project Site of Equipment, Machinery, and Supplies owned by the Contractor;
  - (c) Personal injury or death of Contractor's employees; and
  - (d) Comprehensive insurance for third party liability to Contractor's direct or indirect act or omission causing damage to third persons.
- 15.2. The Contractor shall provide evidence to the Procuring Entity's Representative that the insurances required under this Contract have been effected and shall, within a reasonable time, provide copies of the insurance policies to the Procuring Entity's Representative. Such evidence and such policies shall be provided to the Procuring Entity's through the Procuring Entity's Representative.
- 15.3. The Contractor shall notify the insurers of changes in the nature, extent, or program for the execution of the Works and ensure the adequacy of the insurances at all times in accordance with the terms of this Contract and shall produce to the Procuring Entity's Representative the insurance policies in force including the receipts for payment of the current premiums.
- The above insurance policies shall be obtained from any reputable insurance company approved by the Procuring Entity's Representative.
- 15.4. If the Contractor fails to obtain and keep in force the insurances referred to herein or any other insurance which he may be required to obtain under the terms of this Contract, the Procuring Entity may obtain and keep in force any such insurances and pay such premiums as may be necessary for the purpose. From time to time, the Procuring Entity may deduct the amount it shall pay for said premiums including twenty five percent (25%) therein from any monies due, or which may become due, to the Contractor, without prejudice to the Procuring Entity exercising its right to impose other sanctions against the Contractor pursuant to the provisions of this Contract.
- 15.5. In the event the Contractor fails to observe the above safeguards, the Procuring Entity may, at the Contractor's expense, take whatever measure is deemed necessary for its protection and that of the Contractor's personnel and third parties, and/or order the interruption of dangerous Works. In addition, the Procuring Entity may refuse to make the payments under GCC Clause 40 until the Contractor complies with this Clause.
- 15.6. The Contractor shall immediately replace the insurance policy obtained as required in this Contract, without need of the Procuring Entity's demand, with

a new policy issued by a new insurance company acceptable to the Procuring Entity for any of the following grounds:

- (a) The issuer of the insurance policy to be replaced has:
  - (i) become bankrupt;
  - (ii) been placed under receivership or under a management committee;
  - (iii) been sued for suspension of payment; or
  - (iv) been suspended by the Insurance Commission and its license to engage in business or its authority to issue insurance policies cancelled; or
  - (v) Where reasonable grounds exist that the insurer may not be able, fully and promptly, to fulfill its obligation under the insurance policy.

## **16. Termination for Default of Contractor**

- 16.1. The Procuring Entity shall terminate this Contract for default when any of the following conditions attend its implementation:
- 16.2. Due to the Contractor's fault and while the project is on-going, it has incurred negative slippage of fifteen percent (15%) or more in accordance with Presidential Decree 1870, regardless of whether or not previous warnings and notices have been issued for the Contractor to improve his performance;
- 16.3. Due to its own fault and after this Contract time has expired, the Contractor incurs delay in the completion of the Work after this Contract has expired; or
- 16.4. The Contractor:
  - (a) abandons the contract Works, refuses or fails to comply with a valid instruction of the Procuring Entity or fails to proceed expeditiously and without delay despite a written notice by the Procuring Entity;
  - (b) does not actually have on the project Site the minimum essential equipment listed on the Bid necessary to prosecute the Works in accordance with the approved Program of Work and equipment deployment schedule as required for the project;
  - (c) does not execute the Works in accordance with this Contract or persistently or flagrantly neglects to carry out its obligations under this Contract;
  - (d) neglects or refuses to remove materials or to perform a new Work that has been rejected as defective or unsuitable; or

- (e) sub-lets any part of this Contract without approval by the Procuring Entity.

16.5. All materials on the Site, Plant, Equipment, and Works shall be deemed to be the property of the Procuring Entity if this Contract is rescinded because of the Contractor's default.

## **17. Termination for Default of Procuring Entity**

17.1. The Contractor may terminate this Contract with the Procuring Entity if the works are completely stopped for a continuous period of at least sixty (60) calendar days through no fault of its own, due to any of the following reasons:

- (a) Failure of the Procuring Entity to deliver, within a reasonable time, supplies, materials, right-of-way, or other items it is obligated to furnish under the terms of this Contract; or
- (b) The prosecution of the Work is disrupted by the adverse peace and order situation, as certified by the Armed Forces of the Philippines Provincial Commander and approved by the Secretary of National Defense.

## **18. Termination for Other Causes**

18.1. The Procuring Entity may terminate this Contract, in whole or in part, at any time for its convenience. The Head of the Procuring Entity may terminate this Contract for the convenience of the Procuring Entity if he has determined the existence of conditions that make Project Implementation economically, financially or technically impractical and/or unnecessary, such as, but not limited to, fortuitous event(s) or changes in law and National Government policies.

18.2. The Procuring Entity or the Contractor may terminate this Contract if the other party causes a fundamental breach of this Contract.

18.3. Fundamental breaches of Contract shall include, but shall not be limited to, the following:

- (a) The Contractor stops work for twenty eight (28) days when no stoppage of work is shown on the current Program of Work and the stoppage has not been authorized by the Procuring Entity's Representative;
- (b) The Procuring Entity's Representative instructs the Contractor to delay the progress of the Works, and the instruction is not withdrawn within twenty eight (28) days;
- (c) The Procuring Entity shall terminate this Contract if the Contractor is declared bankrupt or insolvent as determined with finality by a court of competent jurisdiction. In this event, termination will be without compensation to the Contractor, provided that such termination will



not prejudice or affect any right of action or remedy which has accrued or will accrue thereafter to the Procuring Entity and/or the Contractor. In the case of the Contractor's insolvency, any Contractor's Equipment which the Procuring Entity instructs in the notice is to be used until the completion of the Works;

- (d) A payment certified by the Procuring Entity's Representative is not paid by the Procuring Entity to the Contractor within eighty four (84) days from the date of the Procuring Entity's Representative's certificate;
  - (e) The Procuring Entity's Representative gives Notice that failure to correct a particular Defect is a fundamental breach of Contract and the Contractor fails to correct it within a reasonable period of time determined by the Procuring Entity's Representative;
  - (f) The Contractor does not maintain a Security, which is required;
  - (g) The Contractor has delayed the completion of the Works by the number of days for which the maximum amount of liquidated damages can be paid, as defined in the **GCC** Clause 9; and
  - (h) In case it is determined prima facie by the Procuring Entity that the Contractor has engaged, before or during the implementation of the contract, in unlawful deeds and behaviors relative to contract acquisition and implementation, such as, but not limited to, the following:
    - (i) corrupt, fraudulent, collusive and coercive practices as defined in **ITB** Clause 3.1(a);
    - (ii) drawing up or using forged documents;
    - (iii) using adulterated materials, means or methods, or engaging in production contrary to rules of science or the trade; and
    - (iv) any other act analogous to the foregoing.
- 18.4. The Funding Source or the Procuring Entity, as appropriate, will seek to impose the maximum civil, administrative and/or criminal penalties available under the applicable law on individuals and organizations deemed to be involved with corrupt, fraudulent, or coercive practices.
- 18.5. When persons from either party to this Contract gives notice of a fundamental breach to the Procuring Entity's Representative in order to terminate the existing contract for a cause other than those listed under **GCC** Clause 18.3, the Procuring Entity's Representative shall decide whether the breach is fundamental or not.
- 18.6. If this Contract is terminated, the Contractor shall stop work immediately, make the Site safe and secure, and leave the Site as soon as reasonably possible.

## **19. Procedures for Termination of Contracts**

19.1. The following provisions shall govern the procedures for the termination of this Contract:

- (a) Upon receipt of a written report of acts or causes which may constitute ground(s) for termination as aforementioned, or upon its own initiative, the Implementing Unit shall, within a period of seven (7) calendar days, verify the existence of such ground(s) and cause the execution of a Verified Report, with all relevant evidence attached;
- (b) Upon recommendation by the Implementing Unit, the Head of the Procuring Entity shall terminate this Contract only by a written notice to the Contractor conveying the termination of this Contract. The notice shall state:
  - (i) that this Contract is being terminated for any of the ground(s) afore-mentioned, and a statement of the acts that constitute the ground(s) constituting the same;
  - (ii) the extent of termination, whether in whole or in part;
  - (iii) an instruction to the Contractor to show cause as to why this Contract should not be terminated; and
  - (iv) special instructions of the Procuring Entity, if any.

The Notice to Terminate shall be accompanied by a copy of the Verified Report;

- (c) Within a period of seven (7) calendar days from receipt of the Notice of Termination, the Contractor shall submit to the Head of the Procuring Entity a verified position paper stating why the contract should not be terminated. If the Contractor fails to show cause after the lapse of the seven (7) day period, either by inaction or by default, the Head of the Procuring Entity shall issue an order terminating the contract;
- (d) The Procuring Entity may, at anytime before receipt of the Bidder's verified position paper to withdraw the Notice to Terminate if it is determined that certain items or works subject of the notice had been completed, delivered, or performed before the Contractor's receipt of the notice;
- (e) Within a non-extendible period of ten (10) calendar days from receipt of the verified position paper, the Head of the Procuring Entity shall decide whether or not to terminate this Contract. It shall serve a written notice to the Contractor of its decision and, unless otherwise provided in the said notice, this Contract is deemed terminated from receipt of the Contractor of the notice of decision. The termination

shall only be based on the ground(s) stated in the Notice to Terminate;  
and

- (f) The Head of the Procuring Entity may create a Contract Termination Review Committee (CTRC) to assist him in the discharge of this function. All decisions recommended by the CTRC shall be subject to the approval of the Head of the Procuring Entity.

19.2. Pursuant to Section 69(f) of RA 9184 and without prejudice to the imposition of additional administrative sanctions as the internal rules of the agency may provide and/or further criminal prosecution as provided by applicable laws, the procuring entity shall impose on contractors after the termination of the contract the penalty of suspension for one (1) year for the first offense, suspension for two (2) years for the second offense from participating in the public bidding process, for violations committed during the contract implementation stage, which include but not limited to the following:

- (a) Failure of the contractor, due solely to his fault or negligence, to mobilize and start work or performance within the specified period in the Notice to Proceed (“NTP”);
- (b) Failure by the contractor to fully and faithfully comply with its contractual obligations without valid cause, or failure by the contractor to comply with any written lawful instruction of the procuring entity or its representative(s) pursuant to the implementation of the contract. For the procurement of infrastructure projects or consultancy contracts, lawful instructions include but are not limited *to* the following:
  - (i) Employment of competent technical personnel, competent engineers and/or work supervisors;
  - (ii) Provision of warning signs and barricades in accordance with approved plans and specifications and contract provisions;
  - (iii) Stockpiling in proper places of all materials and removal from the project site of waste and excess materials, including broken pavement and excavated debris in accordance with approved plans and specifications and contract provisions;
  - (iv) Deployment of committed equipment, facilities, support staff and manpower; and
  - (v) Renewal of the effectivity dates of the performance security after its expiration during the course of contract implementation.
- (c) Assignment and subcontracting of the contract or any part thereof or substitution of key personnel named in the proposal without prior written approval by the procuring entity.

- (d) Poor performance by the contractor or unsatisfactory quality and/or progress of work arising from his fault or negligence as reflected in the Constructor's Performance Evaluation System ("CPES") rating sheet. In the absence of the CPES rating sheet, the existing performance monitoring system of the procuring entity shall be applied. Any of the following acts by the constructor shall be construed as poor performance:
  - (i) Negative slippage of 15% and above within the critical path of the project due entirely to the fault or negligence of the contractor; and
  - (ii) Quality of materials and workmanship not complying with the approved specifications arising from the contractor's fault or negligence.
- (e) Willful or deliberate abandonment or non-performance of the project or contract by the contractor resulting to substantial breach thereof without lawful and/or just cause.

In addition to the penalty of suspension, the performance security posted by the contractor shall also be forfeited.

## **20. Force Majeure, Release From Performance**

- 20.1. For purposes of this Contract the terms "*force majeure*" and "fortuitous event" may be used interchangeably. In this regard, a fortuitous event or *force majeure* shall be interpreted to mean an event which the Contractor could not have foreseen, or which though foreseen, was inevitable. It shall not include ordinary unfavorable weather conditions; and any other cause the effects of which could have been avoided with the exercise of reasonable diligence by the Contractor.
- 20.2. If this Contract is discontinued by an outbreak of war or by any other event entirely outside the control of either the Procuring Entity or the Contractor, the Procuring Entity's Representative shall certify that this Contract has been discontinued. The Contractor shall make the Site safe and stop work as quickly as possible after receiving this certificate and shall be paid for all works carried out before receiving it and for any Work carried out afterwards to which a commitment was made.
- 20.3. If the event continues for a period of eighty four (84) days, either party may then give notice of termination, which shall take effect twenty eight (28) days after the giving of the notice.
- 20.4. After termination, the Contractor shall be entitled to payment of the unpaid balance of the value of the Works executed and of the materials and Plant reasonably delivered to the Site, adjusted by the following:
  - (a) any sum to which the Contractor is entitled under **GCC** Clause 28;

- (b) the cost of his suspension and demobilization;
- (c) any sum to which the Procuring Entity is entitled.

20.5. The net balance due shall be paid or repaid within a reasonable time period from the time of the notice of termination.

## **21. Resolution of Disputes**

- 21.1. If any dispute or difference of any kind whatsoever shall arise between the parties in connection with the implementation of the contract covered by the Act and this IRR, the parties shall make every effort to resolve amicably such dispute or difference by mutual consultation.
- 21.2. If the Contractor believes that a decision taken by the PROCURING ENTITY's Representative was either outside the authority given to the PROCURING ENTITY's Representative by this Contract or that the decision was wrongly taken, the decision shall be referred to the Arbiter indicated in the **SCC** within fourteen (14) days of the notification of the PROCURING ENTITY's Representative's decision.
- 21.3. Any and all disputes arising from the implementation of this Contract covered by the R.A. 9184 and its IRR shall be submitted to arbitration in the Philippines according to the provisions of Republic Act No. 876, otherwise known as the "Arbitration Law" and Republic Act 9285, otherwise known as the "Alternative Dispute Resolution Act of 2004": *Provided, however,* That, disputes that are within the competence of the Construction Industry Arbitration Commission to resolve shall be referred thereto. The process of arbitration shall be incorporated as a provision in this Contract that will be executed pursuant to the provisions of the Act and its IRR-A: *Provided, further,* That, by mutual agreement, the parties may agree in writing to resort to other alternative modes of dispute resolution. Additional instructions on resolution of disputes, if any, shall be indicated in the **SCC**.

## **22. Suspension of Loan, Credit, Grant, or Appropriation**

In the event that the Funding Source suspends the Loan, Credit, Grant, or Appropriation to the Procuring Entity, from which part of the payments to the Contractor are being made:

- (a) The Procuring Entity is obligated to notify the Contractor of such suspension within seven (7) days of having received the suspension notice.
- (b) If the Contractor has not received sums due it for work already done within forty five (45) days from the time the Contractor's claim for payment has been certified by the Procuring Entity's Representative, the Contractor may immediately issue a suspension of work notice in accordance with **SCC** Clause 45.2.

## **23. Procuring Entity's Representative's Decisions**

- 23.1. Except where otherwise specifically stated, the Procuring Entity's Representative will decide contractual matters between the Procuring Entity and the Contractor in the role representing the Procuring Entity's
- 23.2. The Procuring Entity's Representative may delegate any of his duties and responsibilities to other people, except to the Arbitrator, after notifying the Contractor, and may cancel any delegation after notifying the Contractor.

## **24. Approval of Drawings and Temporary Works by the Procuring Entity's Representative**

- 24.1. All Drawings prepared by the Contractor for the execution of the Temporary Works, are subject to prior approval by the Procuring Entity's Representative before its use.
- 24.2. The Contractor shall be responsible for design of Temporary Works.
- 24.3. The Procuring Entity's Representative's approval shall not alter the Contractor's responsibility for design of the Temporary Works.
- 24.4. The Contractor shall obtain approval of third parties to the design of the Temporary Works, when required by the Procuring Entity.

## **25. Acceleration and Delays Ordered by the Procuring Entity's Representative**

- 25.1. When the Procuring Entity wants the Contractor to finish before the Intended Completion Date, the Procuring Entity's Representative will obtain priced proposals for achieving the necessary acceleration from the Contractor. If the Procuring Entity accepts these proposals, the Intended Completion Date will be adjusted accordingly and confirmed by both the Procuring Entity and the Contractor.
- 25.2. If the Contractor's Financial Proposals for an acceleration are accepted by the Procuring Entity, they are incorporated in the Contract Price and treated as a Variation.

## **26. Extension of the Intended Completion Date**

- 26.1. The Procuring Entity's Representative shall extend the Intended Completion Date if a Variation is issued which makes it impossible for the Intended Completion Date to be achieved by the Contractor without taking steps to accelerate the remaining work, which would cause the Contractor to incur additional costs. Unless specified in the **SCC**, no payment shall be made for any event which may warrant the extension of the Intended Completion Date.
- 26.2. The Procuring Entity's Representative shall decide whether and by how much to extend the Intended Completion Date within twenty one (21) days of the Contractor asking the Procuring Entity's Representative for a decision thereto

after fully submitting all supporting information. If the Contractor has failed to give early warning of a delay or has failed to cooperate in dealing with a delay, the delay by this failure shall not be considered in assessing the new Intended Completion Date.

## **27. Right to Vary**

27.1. The Procuring Entity's Representative with the prior approval of the Procuring Entity may instruct Variations, up to a maximum cumulative amount of ten percent (10%) of the original contract cost.

27.2. Variations shall be valued as follows:

- (a) At a lump sum price agreed between the parties;
- (b) where appropriate, at rates in this Contract;
- (c) in the absence of appropriate rates, the rates in this Contract shall be used as the basis for valuation; or failing which
- (d) at appropriate new rates, equal to or lower than current industry rates and to be agreed upon by both parties and approved by the Head of the Procuring Entity.

## **28. Contractors Right to Claim**

If the Contractor incurs cost as a result of any of the events under **GCC** Clause 13, the Contractor shall be entitled to the amount of such cost. If as a result of any of the said events, it is necessary to change the Works, this shall be dealt with as a Variation.

## **29. Dayworks**

29.1. Subject to **GCC** Clause 43 on Variation Order, and if applicable as indicated in the **SCC**, the Dayworks rates in the Contractor's Bid shall be used for small additional amounts of work only when the Procuring Entity's Representative has given written instructions in advance for additional work to be paid for in that way.

29.2. All work to be paid for as Dayworks shall be recorded by the Contractor on forms approved by the Procuring Entity's Representative. Each completed form shall be verified and signed by the Procuring Entity's Representative within two days of the work being done.

29.3. The Contractor shall be paid for Dayworks subject to obtaining signed Dayworks forms.

## **30. Early Warning**

30.1. The Contractor shall warn the Procuring Entity's Representative at the earliest opportunity of specific likely future events or circumstances that may adversely affect the quality of the work, increase the Contract Price, or delay

the execution of the Works. The Procuring Entity's Representative may require the Contractor to provide an estimate of the expected effect of the future event or circumstance on the Contract Price and Completion Date. The estimate shall be provided by the Contractor as soon as reasonably possible.

- 30.2. The Contractor shall cooperate with the Procuring Entity's Representative in making and considering proposals for how the effect of such an event or circumstance can be avoided or reduced by anyone involved in the work and in carrying out any resulting instruction of the Procuring Entity's Representative.

### **31. Program of Work**

- 31.1. Within the time stated in the **SCC**, the Contractor shall submit to the Procuring Entity's Representative for approval a Program of Work showing the general methods, arrangements, order, and timing for all the activities in the Works.
- 31.2. An update of the Program of Work shall show the actual progress achieved on each activity and the effect of the progress achieved on the timing of the remaining work, including any changes to the sequence of the activities.
- 31.3. The Contractor shall submit to the Procuring Entity's Representative for approval an updated Program of Work at intervals no longer than the period stated in the **SCC**. If the Contractor does not submit an updated Program of Work within this period, the PROCURING ENTITY's Representative may withhold the amount stated in the **SCC** from the next payment certificate and continue to withhold this amount until the next payment after the date on which the overdue Program of Work has been submitted.
- 31.4. The Procuring Entity's Representative's approval of the Program of Work shall not alter the Contractor's obligations. The Contractor may revise the Program of Work and submit it to the Procuring Entity's Representative again at any time. A revised Program of Work shall show the effect of any approved Variations; and if allowed, any Compensation Event.
- 31.5. When the Program of Work is updated, the Contractor shall provide the Procuring Entity's Representative with an updated cash flow forecast. The cash flow forecast shall include different currencies, as defined in the Contract, converted as necessary using the Contract exchange rates.
- 31.6. All Variations shall be included in updated Program of Work produced by the Contractor.

### **32. Management Conferences**

- 32.1. Either the Procuring Entity's Representative or the Contractor may require the other to attend a Management Conference. The Management Conference shall review the plans for remaining work and deal with matters raised in accordance with the early warning procedure.



32.2. The Procuring Entity's Representative shall record the business of Management Conferences and provide copies of the record to those attending the Conference and to the Procuring Entity . The responsibility of the parties for actions to be taken shall be decided by the PROCURING ENTITY's Representative either at the Management Conference or after the Management Conference and stated in writing to all who attended the Conference.

### **33. Bill of Quantities**

33.1. The Bill of Quantities shall contain items of work for the construction, installation, testing, and commissioning of work to be done by the Contractor.

33.2. The Bill of Quantities is used to calculate the Contract Price. The Contractor is paid for the quantity of the work done at the rate in the Bill of Quantities for each item.

33.3. If the final quantity of any work done differs from the quantity in the Bill of Quantities for the particular item and is not more than twenty five percent (25%) of the original quantity, provided the aggregate changes for all items do not exceed ten percent (10%) of the Contract price, the Procuring Entity's Representative shall make the necessary adjustments to allow for the changes subject to applicable laws, rules, and regulations.

33.4. If requested by the Procuring Entity's Representative, the Contractor shall provide the Procuring Entity's Representative with a detailed cost breakdown of any rate in the Bill of Quantities.

### **34. Instructions, Inspections and Audits**

34.1. The Procuring Entity's personnel shall at all reasonable times during construction of the Work be entitled to examine, inspect, measure and test the materials and workmanship, and to check the progress of the construction.

34.2. If the Procuring Entity's Representative instructs the Contractor to carry out a test not specified in the Specification to check whether any work has a defect and the test shows that it does, the Contractor shall pay for the test and any samples. If there is no defect, the test shall be a Compensation Event.

34.3. The Contractor shall permit the Funding Source named in the **SCC** to inspect the Contractor's accounts and records relating to the performance of the Contractor and to have them audited by auditors appointed by the Funding Source, if so required by the Funding Source.

### **35. Identifying Defects**

The Procuring Entity's Representative shall check the Contractor's work and notify the Contractor of any defects that are found. Such checking shall not affect the Contractor's responsibilities. The Procuring Entity's Representative may instruct the Contractor to search uncover defects and test any work that the Procuring Entity's Representative considers below standards and defective.

### **36. Cost of Repairs**

Loss or damage to the Works or Materials to be incorporated in the Works between the Start Date and the end of the Defects Liability Periods shall be remedied by the Contractor at the Contractor's cost if the loss or damage arises from the Contractor's acts or omissions.

### **37. Correction of Defects**

- 37.1. The Procuring Entity's Representative shall give notice to the Contractor of any defects before the end of the Defects Liability Period, which begins at Completion Date up to final acceptance by the Procuring Entity's unless otherwise specified in the **SCC**. The Defects Liability Period shall be extended for as long as defects remain to be corrected.
- 37.2. Every time notice of a defect is given, the Contractor shall correct the notified defect within the length of time specified in the Procuring Entity's Representative's notice.
- 37.3. The Contractor shall correct the defects which he notices himself before the end of the Defects Liability Period.
- 37.4. The Procuring Entity shall certify that all defects have been corrected. If the Procuring Entity considers that correction of a defect is not essential, he can request the Contractor to submit a quotation for the corresponding reduction in the Contract Price. If the Procuring Entity accepts the quotation, the corresponding change in the SCC is a Variation.

### **38. Uncorrected Defects**

- 38.1. The Procuring Entity shall give the Contractor at least fourteen (14) days notice of his intention to use a third party to correct a Defect. If the Contractor does not correct the Defect himself within the period, the Procuring Entity may have the Defect corrected by the third party. The cost of the correction will be deducted from the Contract Price.
- 38.2. The use of a third party to correct defects that are uncorrected by the Contractor will in no way relieve the Contractor of its liabilities and warranties under the Contract.

### **39. Advance Payment**

- 39.1. The Procuring Entity shall, upon a written request of the contractor which shall be submitted as a contract document, make an advance payment to the contractor in an amount not exceeding fifteen percent (15%) of the total contract price, to be made in lump sum or, at the most two, installments according to a schedule specified in the **SCC**.
- 39.2. The advance payment shall be made only upon the submission to and acceptance by the Procuring Entity of an irrevocable standby letter of credit of equivalent value from a commercial bank, a bank guarantee or a surety bond

callable upon demand, issued by a surety or insurance company duly licensed by the Insurance Commission and confirmed by the Procuring Entity.

- 39.3. The advance payment shall be repaid by the Contractor by an amount equal to the percentage of the total contract price used for the advance payment.
- 39.4. The contractor may reduce his standby letter of credit or guarantee instrument by the amounts refunded by the Monthly Certificates in the advance payment.
- 39.5. The Procuring Entity will provide an Advance Payment on the Contract Price as stipulated in the Conditions of Contract, subject to the maximum amount stated in **SCC** Clause 39.1.

#### **40. Progress Payments**

- 40.1. The Contractor may submit a request for payment for Work accomplished. Such request for payment shall be verified and certified by the Procuring Entity's Representative/Project Engineer. Except as otherwise stipulated in the **SCC**, materials and equipment delivered on the site but not completely put in place shall not be included for payment.
- 40.2. The Procuring Entity shall deduct the following from the certified gross amounts to be paid to the contractor as progress payment:
  - (a) Cumulative value of the work previously certified and paid for.
  - (b) Portion of the advance payment to be recouped for the month.
  - (c) Retention money in accordance with the condition of contract.
  - (d) Amount to cover third party liabilities.
  - (e) Amount to cover uncorrected discovered defects in the works.
- 40.3. Payments shall be adjusted by deducting therefrom the amounts for advance payments and retention. The Procuring Entity shall pay the Contractor the amounts certified by the Procuring Entity's Representative within twenty eight (28) days from the date each certificate was issued. Unless otherwise indicated in the **SCC**, no payment of interest for delayed payments and adjustments shall be made by the Procuring Entity.
- 40.4. The first progress payment may be paid by the Procuring Entity to the Contractor provided that at least twenty percent (20%) of the work has been accomplished as certified by the Procuring Entity's Representative.
- 40.5. Items of the Works for which a price of "0" (zero) has been entered will not be paid for by the Procuring Entity and shall be deemed covered by other rates and prices in the Contract.

## **41. Payment Certificates**

- 41.1. The Contractor shall submit to the Procuring Entity's Representative monthly statements of the estimated value of the work executed less the cumulative amount certified previously.
- 41.2. The Procuring Entity's Representative shall check the Contractor's monthly statement and certify the amount to be paid to the Contractor.
- 41.3. The value of Work executed shall:
  - (a) be determined by the Procuring Entity's Representative;
  - (b) comprise the value of the quantities of the items in the Bill of Quantities completed; and
  - (c) include the valuations of approved variations.
- 41.4. The Procuring Entity's Representative may exclude any item certified in a previous certificate or reduce the proportion of any item previously certified in any certificate in the light of later information.

## **42. Retention**

- 42.1. The Procuring Entity shall retain from each payment due to the Contractor an amount equal to a percentage thereof using the rate as specified in **SCC** Clause 42.2.
- 42.2. Progress payments are subject to retention of ten percent (10%), unless otherwise specified in the **SCC**, referred to as the "retention money." Such retention shall be based on the total amount due to the Contractor prior to any deduction and shall be retained from every progress payment until fifty percent (50%) of the value of Works, as determined by the Procuring Entity, are completed. If, after fifty percent (50%) completion, the Work is satisfactorily done and on schedule, no additional retention shall be made; otherwise, the ten percent (10%) retention shall again be imposed using the rate specified therefor.
- 42.3. The total "retention money" shall be due for release upon final acceptance of the Works. The Contractor may, however, request the substitution of the retention money for each progress billing with irrevocable standby letters of credit from a commercial bank, bank guarantees or surety bonds callable on demand, of amounts equivalent to the retention money substituted for and acceptable to the Procuring Entity, provided that the project is on schedule and is satisfactorily undertaken. Otherwise, the ten (10%) percent retention shall be made. Said irrevocable standby letters of credit, bank guarantees and/or surety bonds, to be posted in favor of the Government shall be valid for a duration to be determined by the concerned implementing office/agency or Procuring Entity and will answer for the purpose for which the ten (10%) percent retention is intended, *i.e.*, to cover uncorrected discovered defects and third party liabilities.

- 42.4. On completion of the whole Works, the Contractor may substitute retention money with an “on demand” Bank guarantee in a form acceptable to the Procuring Entity.

### **43. Variation Orders**

- 43.1. Variation Orders may be issued by the Procuring Entity to cover any increase/decrease in quantities, including the introduction of new work items that are not included in the original contract or reclassification of work items that are either due to change of plans, design or alignment to suit actual field conditions resulting in disparity between the preconstruction plans used for purposes of bidding and the “as staked plans” or construction drawings prepared after a joint survey by the Contractor and the Procuring Entity after award of the contract, provided that the cumulative amount of the Variation Order does not exceed ten percent (10%) of the original project cost. The addition/deletion of Works should be within the general scope of the project as bid and awarded. The scope of works shall not be reduced so as to accommodate a positive Variation Order. A Variation Order may either be in the form of a Change Order or Extra Work Order.
- 43.2. A Change Order may be issued by the implementing official to cover any increase/decrease in quantities of original Work items in the contract.
- 43.3. An Extra Work Order may be issued by the implementing official to cover the introduction of new work necessary for the completion, improvement or protection of the project which were not included as items of Work in the original contract, such as, where there are subsurface or latent physical conditions at the site differing materially from those indicated in the contract, or where there are duly unknown physical conditions at the site of an unusual nature differing materially from those ordinarily encountered and generally recognized as inherent in the Work or character provided for in the contract.
- 43.4. Any cumulative Variation Order beyond ten percent (10%) shall be subject of another contract to be bid out if the works are separable from the original contract. In exceptional cases where it is urgently necessary to complete the original scope of work, the Head of the Procuring Entity may authorize a positive Variation Order go beyond ten percent (10%) but not more than twenty percent (20%) of the original contract price, subject to the guidelines to be determined by the GPPB: *Provided, however,* That appropriate sanctions shall be imposed on the designer, consultant or official responsible for the original detailed engineering design which failed to consider the Variation Order beyond ten percent (10%).
- 43.5. In claiming for any Variation Order, the Contractor shall, within seven (7) calendar days after such work has been commenced or after the circumstances leading to such condition(s) leading to the extra cost, and within twenty-eight (28) calendar days deliver a written communication giving full and detailed particulars of any extra cost in order that it may be investigated at that time. Failure to provide either of such notices in the time stipulated shall constitute a waiver by the contractor for any claim. The preparation and submission of Variation Orders are as follows:

- (a) If the Procuring Entity's representative/Project Engineer believes that a Change Order or Extra Work Order should be issued, he shall prepare the proposed Order accompanied with the notices submitted by the Contractor, the plans therefore, his computations as to the quantities of the additional works involved per item indicating the specific stations where such works are needed, the date of his inspections and investigations thereon, and the log book thereof, and a detailed estimate of the unit cost of such items of work, together with his justifications for the need of such Change Order or Extra Work Order, and shall submit the same to the Head of the Procuring Entity for approval.
- (b) The Head of the Procuring Entity or his duly authorized representative, upon receipt of the proposed Change Order or Extra Work Order shall immediately instruct the technical staff of the Procuring Entity's to conduct an on-the-spot investigation to verify the need for the Work to be prosecuted. A report of such verification shall be submitted directly to the Head of the Procuring Entity or his duly authorized representative.
- (c) The, Head of the Procuring Entity or his duly authorized representative, after being satisfied that such Change Order or Extra Work Order is justified and necessary, shall review the estimated quantities and prices and forward the proposal with the supporting documentation to the Head of Procuring Entity for consideration.
- (d) If, after review of the plans, quantities and estimated unit cost of the items of work involved, the proper office of the procuring entity empowered to review and evaluate Change Orders or Extra Work Orders recommends approval thereof, Head of the Procuring Entity or his duly authorized representative, believing the Change Order or Extra Work Order to be in order, shall approve the same.
- (e) The timeframe for the processing of Variation Orders from the preparation up to the approval by the Head of the Procuring Entity concerned shall not exceed thirty (30) calendar days.

#### **44. Contract Completion**

Once the project reaches an accomplishment of ninety five (95%) of the total contract amount, the Procuring Entity may create an inspectorate team to make preliminary inspection and submit a punch-list to the Contractor in preparation for the final turnover of the project. Said punch-list will contain, among others, the remaining Works, Work deficiencies for necessary corrections, and the specific duration/time to fully complete the project considering the approved remaining contract time. This, however, shall not preclude the claim of the Procuring Entity for liquidated damages.

#### **45. Suspension of Work**

45.1. The Procuring Entity shall have the authority to suspend the work wholly or partly by written order for such period as may be deemed necessary, due to

*force majeure* or any fortuitous events or for failure on the part of the Contractor to correct bad conditions which are unsafe for workers or for the general public, to carry out valid orders given by the Procuring Entity or to perform any provisions of the contract, or due to adjustment of plans to suit field conditions as found necessary during construction. The Contractor shall immediately comply with such order to suspend the work wholly or partly.

45.2. The Contractor or its duly authorized representative shall have the right to suspend work operation on any or all projects/activities along the critical path of activities after fifteen (15) calendar days from date of receipt of written notice from the Contractor to the district engineer/regional director/consultant or equivalent official, as the case may be, due to the following:

- (a) There exist right-of-way problems which prohibit the Contractor from performing work in accordance with the approved construction schedule.
- (b) Requisite construction plans which must be owner-furnished are not issued to the contractor precluding any work called for by such plans.
- (c) Peace and order conditions make it extremely dangerous, if not possible, to work. However, this condition must be certified in writing by the Philippine National Police (PNP) station which has responsibility over the affected area and confirmed by the Department of Interior and Local Government (DILG) Regional Director.
- (d) There is failure on the part of the Procuring Entity to deliver government-furnished materials and equipment as stipulated in the contract.
- (e) Delay in the payment of Contractor's claim for progress billing beyond forty-five (45) calendar days from the time the Contractor's claim has been certified to by the procuring entity's authorized representative that the documents are complete unless there are justifiable reasons thereof which shall be communicated in writing to the Contractor.

45.3. In case of total suspension, or suspension of activities along the critical path, which is not due to any fault of the Contractor, the elapsed time between the effective order of suspending operation and the order to resume work shall be allowed the Contractor by adjusting the contract time accordingly.

## **46. Payment on Termination**

46.1. If the Contract is terminated because of a fundamental breach of Contract by the Contractor, the Procuring Entity's Representative shall issue a certificate for the value of the work done and Materials ordered less advance payments received up to the date of the issue of the certificate and less the percentage to apply to the value of the work not completed, as indicated in the SCC. Additional Liquidated Damages shall not apply. If the total amount due to the Procuring Entity exceeds any payment due to the Contractor, the difference shall be a debt payable to the Procuring Entity.

- 46.2. If the Contract is terminated for the Procuring Entity's convenience or because of a fundamental breach of Contract by the Procuring Entity, the Procuring Entity's Representative shall issue a certificate for the value of the work done, Materials ordered, the reasonable cost of removal of Equipment, repatriation of the Contractor's personnel employed solely on the Works, and the Contractor's costs of protecting and securing the Works, and less advance payments received up to the date of the certificate.
- 46.3. The net balance due shall be paid or repaid within twenty eight (28) days from the notice of termination.
- 46.4. If the Contractor has terminated the Contract under GCC Clauses 17 or 18, the Procuring Entity shall promptly return the Performance Security to the Contractor.

#### **47. Extension of Contract Time**

- 47.1. Should the amount of additional work of any kind or other special circumstances of any kind whatsoever occur such as to fairly entitle the contractor to an extension of contract time, the Procuring Entity shall determine the amount of such extension; provided that the Procuring Entity is not bound to take into account any claim for an extension of time unless the Contractor has, prior to the expiration of the contract time and within thirty (30) calendar days after such work has been commenced or after the circumstances leading to such claim have arisen, delivered to the Procuring Entity notices in order that it could have investigated them at that time. Failure to provide such notice shall constitute a waiver by the Contractor of any claim. Upon receipt of full and detailed particulars, the Procuring Entity shall examine the facts and extent of the delay and shall extend the contract time completing the contract work when, in the Procuring Entity's opinion, the findings of facts justify an extension.
- 47.2. No extension of contract time shall be granted the Contractor due to (a) ordinary unfavorable weather conditions and (b) inexcusable failure or negligence of Contractor to provide the required equipment, supplies or materials.
- 47.3. Extension of contract time may be granted only when the affected activities fall within the critical path of the PERT/CPM network.
- 47.4. No extension of contract time shall be granted when the reason given to support the request for extension was already considered in the determination of the original contract time during the conduct of detailed engineering and in the preparation of the contract documents as agreed upon by the parties before contract perfection.
- 47.5. Extension of contract time shall be granted for rainy/unworkable days considered unfavorable for the prosecution of the works at the site, based on the actual conditions obtained at the site, in excess of the number of rainy/unworkable days pre-determined by the Procuring Entity in relation to the original contract time during the conduct of detailed engineering and in the



preparation of the contract documents as agreed upon by the parties before contract perfection, and/or for equivalent period of delay due to major calamities such as exceptionally destructive typhoons, floods and earthquakes, and epidemics, and for causes such as non-delivery on time of materials, working drawings, or written information to be furnished by the Procuring Entity, non-acquisition of permit to enter private properties within the right-of-way resulting in complete paralyzation of construction activities, and other meritorious causes as determined by the Procuring Entity's Representative and approved by the Head of the Procuring Entity. Shortage of construction materials, general labor strikes, and peace and order problems that disrupt construction operations through no fault of the Contractor may be considered as additional grounds for extension of contract time provided they are publicly felt and certified by appropriate government agencies such as DTI, DOLE, DILG, and DND, among others. The written consent of bondsmen must be attached to any request of the Contractor for extension of contract time and submitted to the Procuring Entity for consideration and the validity of the Performance Security shall be correspondingly extended.

#### **48. Price Adjustment**

Except for extraordinary circumstances as determined by NEDA and approved by the GPPB, no price adjustment shall be allowed unless otherwise specified in the **SCC**.

#### **49. Completion**

The Contractor shall request the Procuring Entity's Representative to issue a certificate of Completion of the Works, and the Procuring Entity's Representative will do so upon deciding that the work is completed.

#### **50. Taking Over**

The Procuring Entity shall take over the Site and the Works within seven (7) days from the date the Procuring Entity's Representative issues a certificate of Completion.

#### **51. Operating and Maintenance Manuals**

51.1. If "as built" Drawings and/or operating and maintenance manuals are required, the Contractor shall supply them by the dates stated in the **SCC**.

51.2. If the Contractor does not supply the Drawings and/or manuals by the dates stated in the **SCC**, or they do not receive the Procuring Entity's Representative's approval, the Procuring Entity's Representative shall withhold the amount stated in the **SCC** from payments due to the Contractor.

## Section V. Special Conditions of Contract

GCC Clause	
1.16	The <b>Intended Completion Date</b> is ninety (90) calendar days.
1.21	The <b>Procuring Entity</b> is the Department of Budget and Management (DBM) with address at Gen. Solano St., San Miguel, Manila.
1.22	The <b>Procuring Entity's Representative</b> is Dir. Sofia C. Yanto, Administrative Service.
1.23	The <b>Site</b> is located at DBM Building II (Boncodin Hall), Gen. Solano St., San Miguel, Manila and is defined in drawings as indicated in these Bidding Documents.
1.27	The <b>Start Date</b> is the date indicated in the Notice to Proceed.
1.30	The <b>Works</b> consist of fabrication and installation of catwalk for DBM Building 2 Roofing, the repair/replacement of DBM Building II roofing (50% repair and 50% replacement) and waterproofing of concrete gutters at DBM Building II.
2.2	No further instructions.
5.1	The <b>Procuring Entity</b> shall give possession of all parts of the Site to the Contractor upon receipt of the Notice to Proceed.
6	The application, processing, and payment of permits, licenses and other certifications that may be required by the local government unit and/or any government agency for the renovation, completion, and final turn-over and occupation of the building shall be the responsibility of the Contractor.
6.5	The Contractor shall employ the following <b>Key Personnel</b> :  1 Project Engineer (Licensed Civil Engineer w/ min. 5 yrs experience) 1 Foreman (min. 10yrs Experience) 1 Safety Officer (min. 2 yrs experience) 1 Materials Engineer (DPWH accredited)
7.1	No further instructions.
7.4(c)	No further instructions.
8.1	No further instructions.
9.1	The applicable liquidated damages is at least one tenth (1/10) of one percent of the cost of the unperformed portion for every day of delay.  The maximum deduction shall be ten percent (10%) of the amount of the contract, the Procuring Entity shall rescind the contract, without prejudice to other courses of action and remedies open to it.
10	None
12.5	One (1) year

13	If the Contractor is a joint venture, all partners to the joint venture shall be jointly and severally liable to the Procuring Entity.
21.2	The appointment of Arbiter shall be made in accordance with the provisions of Republic Act No. 876, otherwise known as the "Arbitration Law" and Republic Act 9285 ("R.A. 9285"), otherwise known as the "Alternative Dispute Resolution Act of 2004."
21.3	No further instructions.
29.1	No dayworks are applicable to the contract.
31.1	The Contractor shall submit the Program of Work to the Procuring Entity's Representative within five (5) calendar days from acceptance of the Notice of Award.
31.3	The period between Program of Work updates is seven (7) days.  The amount to be withheld for late submission of an updated Program of Work is ten percent (10%) of the amount of the next progress billing.
34.3	The Funding Source is the Government of the Philippines (GOP) through the authorized appropriations under the FY 2013 General Appropriations Act in the amount of <b>Three Million Seven Hundred Twelve Thousand Pesos (P3,712,000.00)</b> .
37.1	No further instructions.
39.1	The amount of the advance payment is fifteen percent (15%) of the Contract Price, which shall be given to the Contractor not later than fifteen (15) calendar days from receipt by the Procuring Entity of the Contractor's request, subject to the requirements under GCC Clause 39.2.
40.1	No further instructions.
51.1	The "as built" drawings and operating and maintenance manuals shall be submitted within ten (10) calendar days from accomplishment of ninety-five percent (95%) of the Project.
51.2	In addition to the withholding of retention money, the Procuring Entity's Representative shall withhold Thirty Thousand Pesos (P30,000.00) from payments due to the Contractor in case of failure to deliver the "as built" drawings and operating and maintenance manuals within the period indicated under SCC Clause 51.1.

## Section VI. Specifications

### A. SCOPE OF WORK:

1. The work contemplated under this contract consists of:
  - a) Furnishing of all necessary materials, labor and tools for the complete construction of the building in accordance with the plans and specifications herewith submitted.
  - b) All works to be done shall be in the highest quality of workmanship to the fullest intent and meaning of the plans and specifications unless otherwise specified.

### B. PLANS AND SPECIFICATIONS:

1. The plans and specification shall be considered as cooperatives and all labor materials in one and not mentioned or indicated in other or vice versa and shall not be done by the contractor as if these are duly mentioned in both.
2. If so, numerical indications appear on the plans, all drawings shall be carefully followed according to the scale of the drawing, but if they are not indicated, the numerical rotations must be followed and not the scale of the drawing and specifications, specifications shall govern. In case of discrepancies on figures or drawings, the matter shall immediately be submitted to the Project -in- charge before any adjustments shall be made.
3. The owner, contractor or workmen without prior agreement or approval, no changes in drawing and specification shall be made.

### C. ROOFING:

1. Roofing:

The roof shall be covered with gauge no. 24 long span metal roofing sheets Tegula contoured pre-painted. Color finish shall be of the same finish as the existing roofs.
2. Flushing and Counter Flushing:

All flushing and counter flushing shall be gauge no. 24 pre-painted metal sheets extent 1" into the wall.
3. Ridge, Valley and Hip Roll:

Ridge, valley and hip rolls shall be of no. 24 tegula pre-painted metal. Ridge and valley rolls shall laps, at least 25cm. Over-roofing sheets. The ridges and valley rolls shall be riveted to the long span metal roofing sheets at every corrugation in addition to rivets engaging top line of straps.
4. Repaired roofing shall be painted with elastomeric paint for steel 2 coats.
5. All materials included herein shall be of pre-painted metal sheets.

**D. CATWALK:**

1. Catwalk platform shall be of 2mm thick checkered plate coated with epoxy primer prior to final coating of quick dry enamel.
2. Steel frame as stated in the plans shall be of sch. 40 for pipes and 3/16" thick for angular steels.
3. All connections shall be fully welded using e60 electrodes.
4. No holes shall be drilled into the existing building/structures.

**E. PAINTING:**

1. General Conditions:
  - a) The contractor shall furnish all labor materials and tools necessary for completion of all painting and varnishing works which includes exposed woodworks and concrete hollow blocks and iron works.
  - b) All paints and varnish materials shall be subject to inspection and approval before any such brand shall be used in this painting works with 2-coats for both interior and exterior surfaces.
2. Concrete and Plaster Works:
  - a) All exposed exterior concrete surfaces shall be painted 2-coats of elastomeric paints.
  - b) All interior concrete and plaster works shall be painted with 2-coats of flat interior wall paint.
3. Color: pre-approved prior to application.

**F. ADDITIONS AND REPAIRS:**

1. In case of additions not shown in the plans and not specified herein, the Contractor shall be paid as additional amount corresponding to the work added.
2. Demolitions and repairs due to Contractor's fault shall be done by the Contractor without extra compensation to the Owner.

**G. RESTRICTIONS:**

1. The Owner shall not be allowed to use or to occupy the building not until the following shall be accomplished:
  - a) The building is completely constructed and the same conforms to the plans and specifications.

- b) Termination of work and acceptance thereof the Owner is executed stating thereof accordance with the plans and specifications, and of which the Owner have no complains anymore.

**H. ACCEPTANCE OF WORKS:**

1. As soon the building is satisfactory inspected and it conforms to the plans and specifications, the contractor shall submit to the Owner a written notice that said building is ready for occupancy and is subject to the latter's approval.
2. Within seven (7) days after receipt of notice, his/her authorized representatives shall execute notice of approval of the said building.
3. Upon inspection of an affidavit that the Owner has approved the completion of the building and acceptance thereof, the work is automatically terminated.

## Section VII. Drawings

**The actual Drawings are annexed to, and shall form part of, this Bidding Documents. Stated below are the number of drawings and their respective descriptions:**

1. Site Development Plan
2. Existing DBM Roof Plan
3. Proposed Catwalk Layout
4. Proposed Repair/Replacement of Roof
5. Proposed Re-application of Water Proofing Paint
6. Perspective View of Catwalk
7. Elevation Plan of Catwalk
8. Steel Ladder Detail

## Section VIII. Bill of Quantities

BILL OF QUANTITIES									
SUMMARY									
									Sheet no. 1
<b>PROJECT: Repair/Rehabilitation of DBM Building II Roofs and Gutters and Installation of Roof Catwalk</b>									
<b>LOCATION: DBM Building II, General Solano St., San Miguel, Manila</b>									
DESCRIPTION	QTY		MATERIAL COST			LABOR COST		TOTAL	
	# Units	U.M.	P/Units	Total	P/Unit	Total			
<b>SUMMARY/BY CONTRACT</b>									
Fabrication and Installation of Catwalk for DBM Building 2 Roofing	1	lot							
Repair/Replacement of DBM Building II roofing (50% replacement & 50% repair)	1	lot							
Waterproofing of concrete gutters at DBM Building II	1	lot							
		<b>Total</b>							
<b>I. DIRECT COST</b>									
a. MATERIAL COST									
b. LABOR COST									
<b>TOTAL DIRECT COST</b>									
<b>II. INDIRECT COST</b>									
a. OVERHEAD/CONT/MISC (OCM)									
b. CONTRACTOR'S PROFIT									
c. VAT									
<b>TOTAL INDIRECT COST</b>									
<b>TOTAL PROJECT COST</b>									
Submitted by:									
Name of Company / Bidder					Signature over Printed Name of Representative				Date



BILL OF QUANTITIES									
DETAILS									
									Sheet no. 2
<b>PROJECT: Repair/Rehabilitation of DBM Building II Roofs and Gutters and Installation of Roof Catwalk</b>									
<b>LOCATION: DBM Building II, General Solano St., San Miguel, Manila</b>									
DESCRIPTION		QTY		MATERIAL COST		LABOR COST		TOTAL	
		# Units	U.M.	P/Units	Total	P/Unit	Total		
<b>Fabrication and Installation of Catwalk for DBM Building 2 Roofing</b>									
3" dia. X 6m BI pipe Sch. 40		20	pcs						
2" dia. X 6m GI pipe sch. 40		12	pcs						
1 1/2" dia. X 6m GI Pipe Sch. 40		10	pcs						
2"X2"X3/16"X6m Angle bar		176	pcs						
12mm x 4ft x 8ft MS plate		0.5	pcs						
10mm x 4ft x 8ft MS plate		1	pcs						
2mmx4ftx8ft checkered plate		45	pcs						
welding rod 6013 1/8"		6	20kg/box						
grinding disk 4"		24	pcs						
metal cut-off wheel 14"		6	pcs						
oxy-acetylene		5	set						
epoxy primer w/ catalyst gray		30	gallons						
Quick Dry Enamel (color: red)		30	gallons						
Epoxy reducer		5	gallons						
Paint thinner		5	gallons						
7" paint roller w/ holder		10	pcs						
2" paint brush		10	pcs						
Silicone sealant with gun		20	tubes						
3/4" marine plywood as temporar		10	pcs						
Equipment Rental (Labor cost)		1	lot	-	-	-	-	-	-
			<b>Sub-total</b>						
Submitted by:									
Name of Company / Bidder				Signature over Printed Name				Date	
				of Representative					

BILL OF QUANTITIES							
DETAILS							
							Sheet no. 3
<b>PROJECT: Repair/Rehabilitation of DBM Building II Roofs and Gutters and Installation of Roof Catwalk</b>							
<b>LOCATION: DBM Building II, General Solano St., San Miguel, Manila</b>							
DESCRIPTION	QTY		MATERIAL COST		LABOR COST		TOTAL
	# Units	U.M.	P/Units	Total	P/Unit	Total	
<b>Repair/Replacement of DBM Building II roofing (50% replacement &amp; 50% repair)</b>							
Pre-painted long-span metal roofing (TEGULA) GA. 24	1700	lm					
Pre-painted Ridge roll (tegula) GA. 24 x 2.44m	70	pcs					
Pre-painted Valley gutter GA 24 x 2.44m	20	pcs					
Pre-painted end wall flashing GA 24 x 2.44m	16	pcs					
steel tekscrew	28000	pcs					
tekscrew drill adaptor	20	pcs					
elastomeric paint for roofing	100	gallons					
Paint roller 7" with holder	20	pcs					
Paint Brush 2"	20	pcs					
silicone sealant	200	tubes					
sealant gun	20	pcs					
metal cut-off wheel 4"	10	pcs					
Labor for the repair/rehabilitation of roofs	1	lot	-	-	-	-	
Equipment Rentals	1	lot	-	-	-	-	
		<b>Sub-total</b>					
<b>Waterproofing of concrete gutters at DBM Building II</b>							
Elastomeric paint for concrete	80	gallons					
7" paint roller w/ holder	20	pcs					
2" paint brush	20	pcs					
paint basin	20	pcs					
spatula	10	pcs					
putty plate	5	pairs					
Labor for cleaning and clearing of gutter	1	lot	-	-	-	-	
		<b>Sub-total</b>					
Submitted by:							
Name of Company / Bidder				Signature over Printed Name			Date
				of Representative			

## Section IX. Bidding Forms

### TABLE OF CONTENTS

Bid Form .....	76
Form of Contract Agreement .....	78
Omnibus Sworn Statement .....	80
<b>Credit Line Certificate.....</b>	<b>82</b>
<b>Affidavit of Site Inspection.....</b>	<b>83</b>
<b>Bid Security: Bank Guarantee.....</b>	<b>84</b>
<b>Bid Security: Surety Bond.....</b>	<b>85</b>
<b>Statement of Availability of Key Personnel and Equipment.....</b>	<b>86</b>
<b>Statement of Similar Completed Infrastructure Projects.....</b>	<b>87</b>
<b>Statement of All Ongoing Infrastructure Projects.....</b>	<b>88</b>
<b>List of Key Personnel to be Assigned to the Contract.....</b>	<b>89</b>
<b>List of Equipment Pledged to the Contract.....</b>	<b>90</b>

Bid Form

Date: \_\_\_\_\_

**The Chairperson**

DBM-Bids and Awards Committee

Department of Budget and Management

Malacanang, Manila

Gentlemen and/or Ladies:

Having examined the Bidding Documents including Bid Bulletin Numbers *[insert numbers]*, the receipt of which is hereby duly acknowledged, we, the undersigned, offer to repair/rehabilitate the DBM Building II roofs and gutters and install the roof catwalk in conformity with the said Bidding Documents for the sum of \_\_\_\_\_ Pesos (₱\_\_\_\_\_).

PARTICULARS	PRICE
Repair/Rehabilitation of DBM Building II Roofs and Gutters and Installation of Roof Catwalk	
<i>*Total (Inclusive of VAT)</i>	

\* The total bid shall be equal to the total of the cost breakdown stated in the Bill of Quantities.

We undertake, if our Bid is accepted, to deliver the goods in accordance with the delivery schedule specified in the Schedule of Requirements.

If our Bid is accepted, we undertake to provide a performance security in the form, amounts, and within the times specified in the Bidding Documents.

We agree to abide by this Bid for the Bid Validity Period specified in **BDS** provision for **ITB** Clause 18.2 and it shall remain binding upon us and may be accepted at any time before the expiration of that period.

Until a formal Contract is prepared and executed, this Bid, together with your written acceptance thereof and your Notice of Award, shall be binding upon us.

We understand that you are not bound to accept the lowest or any Bid you may receive.

We certify/confirm that we comply with the eligibility requirements as per **ITB** Clause 5 of the Bidding Documents.

Dated this \_\_\_\_\_ day of \_\_\_\_\_ 20\_\_\_\_\_.

\_\_\_\_\_

\_\_\_\_\_

*[signature]*

*[in the capacity of]*

Duly authorized to sign Bid for and on behalf of \_\_\_\_\_

Form of Contract Agreement

---

THIS AGREEMENT, made this *[insert date]* day of *[insert month]*, *[insert year]* between *[name and address of PROCURING ENTITY]* (hereinafter called the “Entity”) and *[name and address of Contractor]* (hereinafter called the “Contractor”).

WHEREAS, the Entity is desirous that the Contractor execute *[name and identification number of contract]* (hereinafter called “the Works”) and the Entity has accepted the Bid for *[insert the amount in specified currency in numbers and words]* by the Contractor for the execution and completion of such Works and the remedying of any defects therein.

NOW THIS AGREEMENT WITNESSETH AS FOLLOWS:

1. In this Agreement, words and expressions shall have the same meanings as are respectively assigned to them in the Conditions of Contract hereinafter referred to.
2. The following documents shall be attached, deemed to form, and be read and construed as part of this Agreement, to wit:
  - (a) General and Special Conditions of Contract;
  - (b) Drawings/Plans;
  - (c) Specifications;
  - (d) Invitation to Bid;
  - (e) Instructions to Bidders;
  - (f) Bid Data Sheet;
  - (g) Addenda and/or Supplemental/Bid Bulletins, if any;
  - (h) Bid form, including all the documents/statements contained in the Bidder’s bidding envelopes, as annexes;
  - (i) Eligibility requirements, documents and/or statements;
  - (j) Performance Security;
  - (k) Credit line issued by a licensed bank, if any;
  - (l) Notice of Award of Contract and the Bidder’s conforme thereto;
  - (m) Other contract documents that may be required by existing laws and/or the Entity.

3. In consideration of the payments to be made by the Entity to the Contractor as hereinafter mentioned, the Contractor hereby covenants with the Entity to execute and complete the Works and remedy any defects therein in conformity with the provisions of this Contract in all respects.
4. The Entity hereby covenants to pay the Contractor in consideration of the execution and completion of the Works and the remedying of defects wherein, the Contract Price or such other sum as may become payable under the provisions of this Contract at the times and in the manner prescribed by this Contract.

IN WITNESS whereof the parties thereto have caused this Agreement to be executed the day and year first before written.

Signed, sealed, delivered by \_\_\_\_\_ the \_\_\_\_\_ (for the Entity)

Signed, sealed, delivered by \_\_\_\_\_ the \_\_\_\_\_ (for the Contractor).

Binding Signature of PROCURING ENTITY

\_\_\_\_\_

Binding Signature of Contractor

\_\_\_\_\_

*[Addendum showing the corrections, if any, made during the Bid evaluation should be attached with this agreement]*

REPUBLIC OF THE PHILIPPINES )  
CITY/MUNICIPALITY OF \_\_\_\_\_ ) S.S.

**AFFIDAVIT**

I, *[Name of Affiant]*, of legal age, *[Civil Status]*, *[Nationality]*, and residing at *[Address of Affiant]*, after having been duly sworn in accordance with law, do hereby depose and state that:

1. **Select one, delete the other:**

*If a sole proprietorship:* I am the sole proprietor of *[Name of Bidder]* with office address at *[address of Bidder]*;

*If a partnership, corporation, cooperative, or joint venture:* I am the duly authorized and designated representative of *[Name of Bidder]* with office address at *[address of Bidder]*;

2. **Select one, delete the other:**

*If a sole proprietorship:* As the owner and sole proprietor of *[Name of Bidder]*, I have full power and authority to do, execute and perform any and all acts necessary to represent it in the bidding for *[Name of the Project]* of the *[Name of the Procuring Entity]*;

*If a partnership, corporation, cooperative, or joint venture:* I am granted full power and authority to do, execute and perform any and all acts necessary and/or to represent the *[Name of Bidder]* in the bidding as shown in the attached *[state title of attached document showing proof of authorization (e.g., duly notarized Secretary's Certificate issued by the corporation or the members of the joint venture)]*;

3. *[Name of Bidder]* is not "blacklisted" or barred from bidding by the Government of the Philippines or any of its agencies, offices, corporations, or Local Government Units, foreign government/foreign or international financing institution whose blacklisting rules have been recognized by the Government Procurement Policy Board;
4. Each of the documents submitted in satisfaction of the bidding requirements is an authentic copy of the original, complete, and all statements and information provided therein are true and correct;
5. *[Name of Bidder]* is authorizing the Head of the Procuring Entity or its duly authorized representative(s) to verify all the documents submitted;



6. **Select one, delete the rest:**

*If a sole proprietorship:* I am not related to the Head of the Procuring Entity, members of the Bids and Awards Committee (BAC), the Technical Working Group, and the BAC Secretariat, the head of the Project Management Office or the end-user unit, and the project consultants by consanguinity or affinity up to the third civil degree;

*If a partnership or cooperative:* None of the officers and members of [Name of Bidder] is related to the Head of the Procuring Entity, members of the Bids and Awards Committee (BAC), the Technical Working Group, and the BAC Secretariat, the head of the Project Management Office or the end-user unit, and the project consultants by consanguinity or affinity up to the third civil degree;

*If a corporation or joint venture:* None of the officers, directors, and controlling stockholders of [Name of Bidder] is related to the Head of the Procuring Entity, members of the Bids and Awards Committee (BAC), the Technical Working Group, and the BAC Secretariat, the head of the Project Management Office or the end-user unit, and the project consultants by consanguinity or affinity up to the third civil degree;

7. [Name of Bidder] complies with existing labor laws and standards; and
8. [Name of Bidder] is aware of and has undertaken the following responsibilities as a Bidder:
- a) Carefully examine all of the Bidding Documents;
  - b) Acknowledge all conditions, local or otherwise, affecting the implementation of the Contract;
  - c) Made an estimate of the facilities available and needed for the contract to be bid, if any; and
  - d) Inquire or secure Supplemental/Bid Bulletin(s) issued for the [Name of the Project].

IN WITNESS WHEREOF, I have hereunto set my hand this \_\_\_ day of \_\_\_, 20\_\_ at \_\_\_\_\_, Philippines.

\_\_\_\_\_  
Bidder's Representative/Authorized Signatory

[JURAT]

# CREDIT LINE CERTIFICATE

Date: \_\_\_\_\_

Name of the Head of the Procuring Entity

Name of the Procuring Entity

Address of the Procuring Entity

CONTRACT/PROJECT: \_\_\_\_\_

COMPANY/FIRM: \_\_\_\_\_

ADDRESS: \_\_\_\_\_

BANK/FINANCING INSTITUTION: \_\_\_\_\_

ADDRESS: \_\_\_\_\_

AMOUNT: \_\_\_\_\_

This is to certify that the above Bank/Financing Institution with business address indicated above, commits to provide the (Supplier/Distributor/Manufacturer/Contractor), if awarded the above-mentioned Contract, a credit line in the amount specified above which shall be exclusively used to finance the performance of the above-mentioned contract subject to our terms, conditions and requirements.

The credit line shall be available within fifteen (15) calendar days after receipt by the (Supplier/Distributor/Manufacturer/Contractor) of the Notice of Award and such line of credit shall be maintained for one hundred twenty (120) calendar days from the date of opening of bids.

This Certification is being issued in favor of said (Supplier/Distributor Manufacturer/Contractor) in connection with the bidding requirement of (Name of Procuring Entity) for the above-mentioned Contract. We are aware that any false statements issued by us make us liable for perjury.

Name and Signature of Authorized Financing Institution Officer:

\_\_\_\_\_

Official Designation

Concurred By:

Name & Signature of (Supplier/Distributor/Manufacturer/Contractor's)

Authorized Representative : \_\_\_\_\_

Official Designation

Note: The amount should be machine validated.

SUBSCRIBED AND SWORN TO BEFORE ME, this \_\_\_\_ day of \_\_\_\_\_, 2010 in the City of \_\_\_\_\_. Affiant exhibiting to me his/her Valid Identification \_\_\_\_\_, Number\_\_\_\_\_.

Notary Public

REPUBLIC OF THE PHILIPPINES )  
CITY/MUNICIPALITY OF \_\_\_\_\_ ) S.S.

**AFFIDAVIT OF SITE INSPECTION**

I, \_\_\_\_\_, of legal age, \_\_\_\_\_, Filipino  
(Representative of the Bidder) (Civil Status)  
and residing at \_\_\_\_\_,  
(Address of the Representative)  
under oath, hereby depose and say:

1. That I am the \_\_\_\_\_ of the \_\_\_\_\_,  
(Position in the Bidder) (Name of the Bidder)  
with office at \_\_\_\_\_;  
(Address of the Bidder)
2. That I have inspected the site for \_\_\_\_\_,  
(Name of Contract)  
Located at \_\_\_\_\_ on  
(Location of the Contract)  
\_\_\_\_\_.  
(Date of site inspection)
3. That I am making this statement as part of the requirement for  
the Technical Proposal of the \_\_\_\_\_  
(Name of the Bidder)  
for \_\_\_\_\_ of the  
(Name of the Contract)  
Department of Budget and Management.

IN WITNESS WHEREOF, I hereby affix my signature this \_\_\_\_ day of \_\_\_\_\_,  
20\_\_ at \_\_\_\_\_, Philippines.

\_\_\_\_\_

*Affiant*

SUBSCRIBED AND SWORN TO BEFORE ME, this \_\_\_\_ day of \_\_\_\_\_, 2010 in  
the City of \_\_\_\_\_. Affiant exhibiting to me his/her Valid Identification \_\_\_\_\_,  
Number\_\_\_\_\_.

Notary Public

**BID SECURITY: BANK GUARANTEE**

WHEREAS, *(Name of Bidder)* (hereinafter called the "Bidder") has submitted its bid dated *(date)* for the *(Name of Contract)* (hereinafter called "the Bid").

KNOW ALL MEN by these presents that WE *(Name of Bank)* of *(Name of Country)* having our registered office at *(Address)* hereinafter called "the Bank") are bound unto the Department of Budget and Management (hereinafter called "the Entity") in the sum of *(amount)* for which payment well and truly to be made to the said Entity the Bank binds himself, his successors and assigns by these presents.

SEALED with the Common Seal of the said Bank this \_\_\_\_ day of \_\_\_\_\_, 20\_\_.

The CONDITIONS of this obligation are that:

- 1) if the Bidder withdraws his Bid during the period of bid validity specified in the Form of Bid; or
- 2) if the Bidder does not accept the correction of arithmetical errors of his bid price in accordance with the Instructions to Bidder; or
- 3) if the Bidder having been notified of the acceptance of his bid and award of contract to him by the Entity during the period of bid validity:
  - a) fails or refuses to execute the Form of Contract in accordance with the Instructions to Bidders, if required; or
  - b) fails or refuses to furnish the performance Security in accordance with the Instructions to Bidders;

we undertake to pay to the Entity up to the above amount upon receipt of his first written demand, without the Entity having to substantiate its demand, provided that in his demand the Entity will note that the amount claimed by it is due to the occurrence of any one or combination of the three (3) conditions stated above.

The Guarantee will remain in force up to and including the date *(no. of days)* days after the deadline for submission of Bids as such deadline is stated in the Instructions to Bidders or as it may be extended by the Entity, note of which extension(s) to the Bank is hereby waived. Any demand in respect of this Guarantee should reach the Bank not later than the above date.

DATE \_\_\_\_\_ SIGNATURE OF THE BANK \_\_\_\_\_

WITNESS \_\_\_\_\_ SEAL \_\_\_\_\_

\_\_\_\_\_  
*(Signature, Name and Address)*

**BID SECURITY: SURETY BOND**

BOND NO.: \_\_\_\_\_ DATE BOND EXECUTED: \_\_\_\_\_

By this bond, We (*Name of Bidder*) (hereinafter called “the Principal”) as Principal and (*Name of Surety*) of the country of (*Name of Country of Surety*), authorized to transact business in the country of (*Name of Country of Procuring Entity*)

(hereinafter called “the Entity”) as Obligee, in the sum of \_\_\_\_\_, Philippine currency, callable on demand by the Entity for the payment of which sum, well and truly to be made, we, the said Principal and Surety bind ourselves, our successors and assigns, jointly and severally, firmly by these presents.

SEALED with our seals and dated this \_\_\_\_ day of \_\_\_\_\_, 20\_\_\_\_.  
(Day) (Month) (Year)

WHEREAS, the Principal will submit a written Bid to the Entity on the \_\_\_\_ day of \_\_\_\_\_,  
(Day) (Month)  
20\_\_\_\_, for the \_\_\_\_\_ (hereinafter called “the Bid”).  
(Year) (Name of Contract)

NOW, THEREFORE, the conditions of this obligation are that:

- 1) if the Principal withdraws his Bid during the period of bid validity specified in the Form of Bid; or
- 2) if the Principal does not accept the correction of arithmetical errors of his bid price in accordance with the Instruction’s to Bidders; or
- 3) if the Principal having been notified of the acceptance of his Bid and award of contract to him by the Entity during the period of bid validity:
  - a. fails or refuses to execute the Form of Contract in accordance with the Instruction to Bidders, if required; or
  - b. fails or refuses to furnish the Performance Security in accordance with the Instructions to Bidders;

then the Entity shall call on the bond upon a written demand to the Surety, and the Surety shall pay the Entity up to the entered amount of the Bond, upon receipt by the Surety of a written demand from the Entity, without the Entity having to substantiate its demand, provided that, in the demand, the Entity will note that the sum claimed by it is due to the occurrence of any or combination of the three conditions stated above. In this case, this obligations shall remain in full force and effect, otherwise it shall be null and void.

PROVIDED HOWEVER, that the Surety shall not be:

- a) liable for a greater sum than the specified penalty of this bond, nor
- b) liable for a greater sum than the difference between the amount of the said Principal’s Bid and the amount of the Bid that is accepted by the Entity.

This Surety executing this instrument hereby agrees that its obligation shall be valid for one hundred twenty (120) calendar days after the deadline for submission of Bids as such deadline is stated in the Instructions to Bidders or as it may be extended by the Entity, notice of which extension(s) to the Surety is hereby waived.

PRINCIPAL \_\_\_\_\_ SURETY \_\_\_\_\_

SIGNATURE(S) \_\_\_\_\_ SIGNATURE(S) \_\_\_\_\_

NAME(S) AND TITLE(S) \_\_\_\_\_ NAME(S) \_\_\_\_\_

SEAL \_\_\_\_\_

SEAL \_\_\_\_\_

### Statement of Availability of Key Personnel and Equipment

(Date of Issuance)

Name of the Head of the Procuring Entity  
Position of the Head of the Procuring Entity  
(Name of Procuring Entity)  
(Address of Procuring Entity)

Attention : The Chairman  
Bids and Awards Committee

Dear \_\_\_\_\_:

In compliance with the requirements of the (Name of the Procuring Entity) BAC for the bidding of the (Name of the Project) (“the Project”), we certify that (Name of the Bidder) has in its employ key personnel, such as a project managers, project engineers, a materials engineer and foremen, who will be engaged for the construction of the said Project.

Further, we likewise certify the availability of equipment that (Name of the Bidder) owns, has under lease, and/or has under purchase agreements, that may be used for the Project.

Very truly yours,

(Name of Representative)  
(Position)  
(Name of Bidder)

## **Statement of Completed Infrastructure Projects**

## **Statement of Ongoing Infrastructure Projects**



## **List of Key Personnel**

## **List of Equipment**

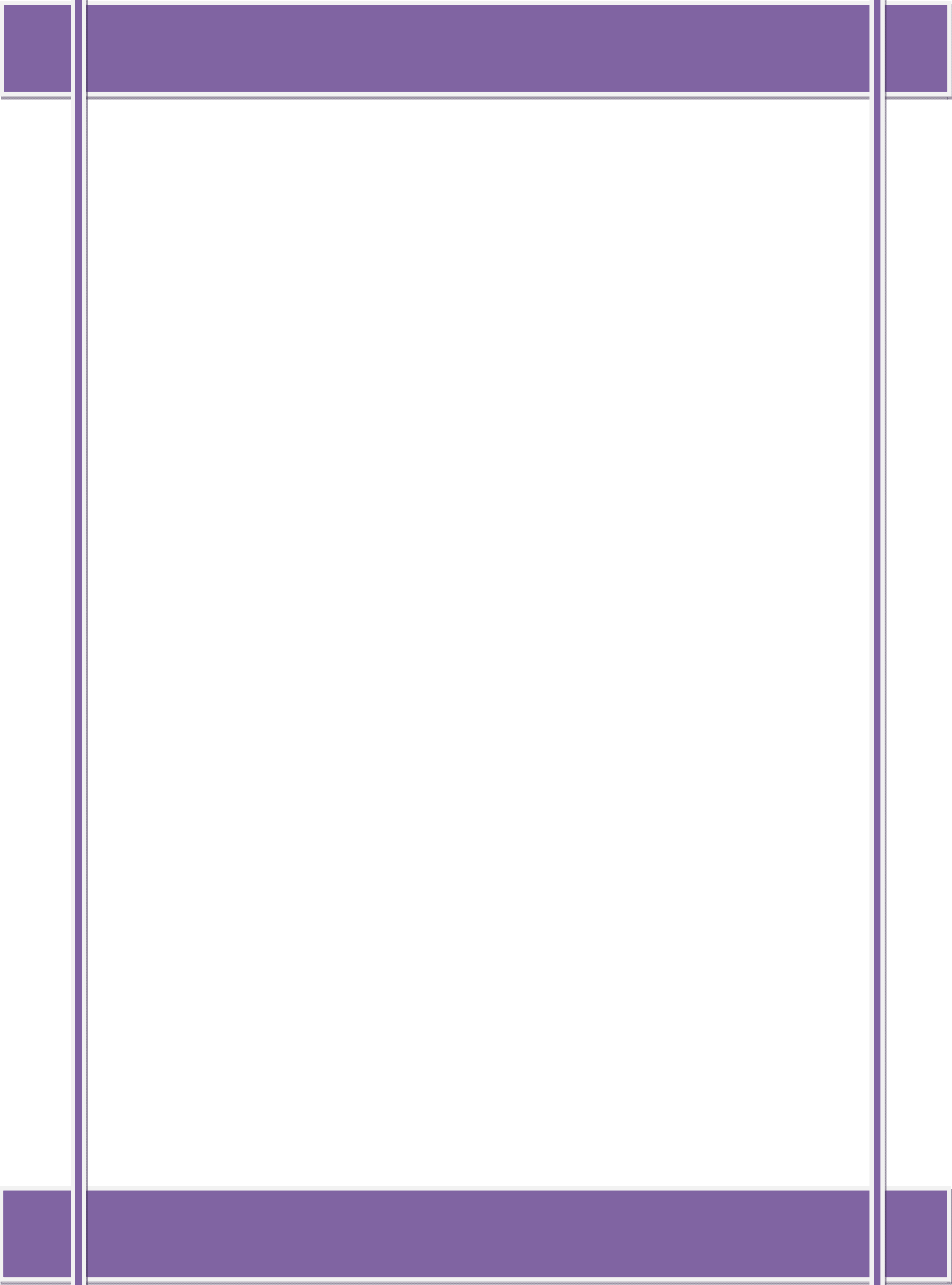

**LIST OF EQUIPMENT, OWNED OR LEASED AND/OR UNDER PURCHASE AGREEMENTS, PLEDGED TO THE PROPOSED CONTRACT**

Business Name : \_\_\_\_\_  
 Business Address : \_\_\_\_\_  
 \_\_\_\_\_

Description	Model/Year	Capacity/ Performance/Size	Plate No.	Motor No./ Body No.	Location	Condition	Proof of Ownership/ Lessor or Vendor
A. Owned							
i.							
ii.							
iii.							
iv.							
v.							
B. Leased							
i.							
ii.							
iii.							
iv.							
v.							
C. Under Purchase Agreements							
i.							
ii.							
iii.							
iv.							
V							

- Notes:
1. This List must be supported by proof of ownership, lease and/or purchase agreements. For lease and purchase agreements, such proof must include a certification of availability of equipment from the lessor/vendor for the duration of the project.
  2. The minimum required equipment to be provided by the contractor are the following:
    - a. 2 units 300 Amp welding machine
    - b. 2 units electric grinders
    - c. 6 units electric drills
  3. The Bidder may provide additional equipment to the minimum requirement as it may deem necessary for the works, to be included in the list above.

Submitted by : \_\_\_\_\_  
 (Printed Name & Signature of Authorized Representative)  
 Designation : \_\_\_\_\_  
 Date : \_\_\_\_\_

**LIST OF KEY PERSONNEL PROPOSED TO BE ASSIGNED TO THE CONTRACT**

Business Name : \_\_\_\_\_  
 Business Address : \_\_\_\_\_

	Project Engineer	Foreman	Safety Officer	Materials Engineer
1 Name				
2 Address				
3 Date of Birth				
4 Employed Since				
5 Experience				
6 Previous Employment				
7 Education				
8 PRC License				
9 Cost of Biggest Project Handled				
10 Years of Experience in Proposed Position				

Notes:

1. This List must be supported by individual resumes and photocopies of PRC Licenses of all personnel, where it may be applicable.
2. The winning Bidder may assign additional personnel, as it may deem necessary, other than those mandatory key personnel listed above.

Submitted by : \_\_\_\_\_  
*(Printed Name & Signature)*  
 Designation : \_\_\_\_\_  
 Date : \_\_\_\_\_

Name of Procuring Entity

Name of Contract

Location of Contract

**Statement of all Completed Government & Private Construction Contracts which are similar in nature**

Business Name : \_\_\_\_\_

Business Address : \_\_\_\_\_

Name of Contract	a. Owner Name b. Address c. Telephone Nos.	Nature of Work	Contractor's Role		a. Amount at Award	a. Date Awarded
			Description	%	b. Amount at Completion	b. Contract Effectivity
Government						
Private						

Note: This statement shall include the Single Largest Contract with Certificate of Final Acceptance or CPES final rating sheet and/or Certificate of Completion, with satisfactory rating.

Submitted by : \_\_\_\_\_

(Printed Name & Signature)

Designation : \_\_\_\_\_

Date : \_\_\_\_\_

Name of Procuring Entity

Name of Contract

Location of Contract

**Statement of all Ongoing Government & Private Construction Contracts including contracts awarded but not yet started**

Business Name : \_\_\_\_\_

Business Address : \_\_\_\_\_

Name of Contract/Location Project Cost	a. Owner Name b. Address c. Telephone Nos.	Nature of Work	Contractor's Role		a. Date Awarded b. Date Started c. Date of	% of Accomplishment		Value of Outstanding Works
			Description	%		Planned	Actual	
Government								
Private								

Submitted by : \_\_\_\_\_

(Printed Name & Signature)

Designation : \_\_\_\_\_

Date : \_\_\_\_\_

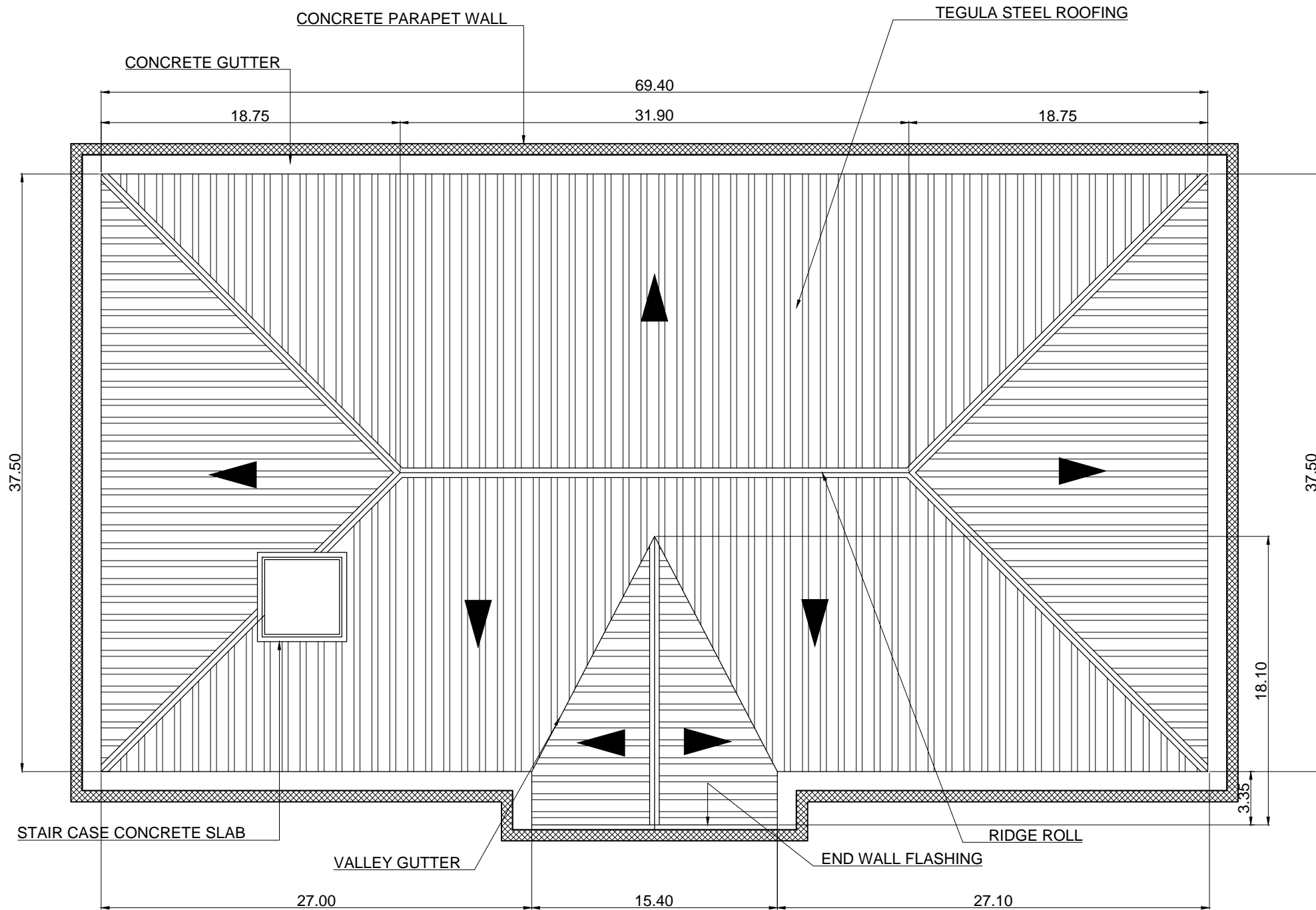

1  
S 1  
EXISTING DBM ROOF PLAN  
SCALE : NTS



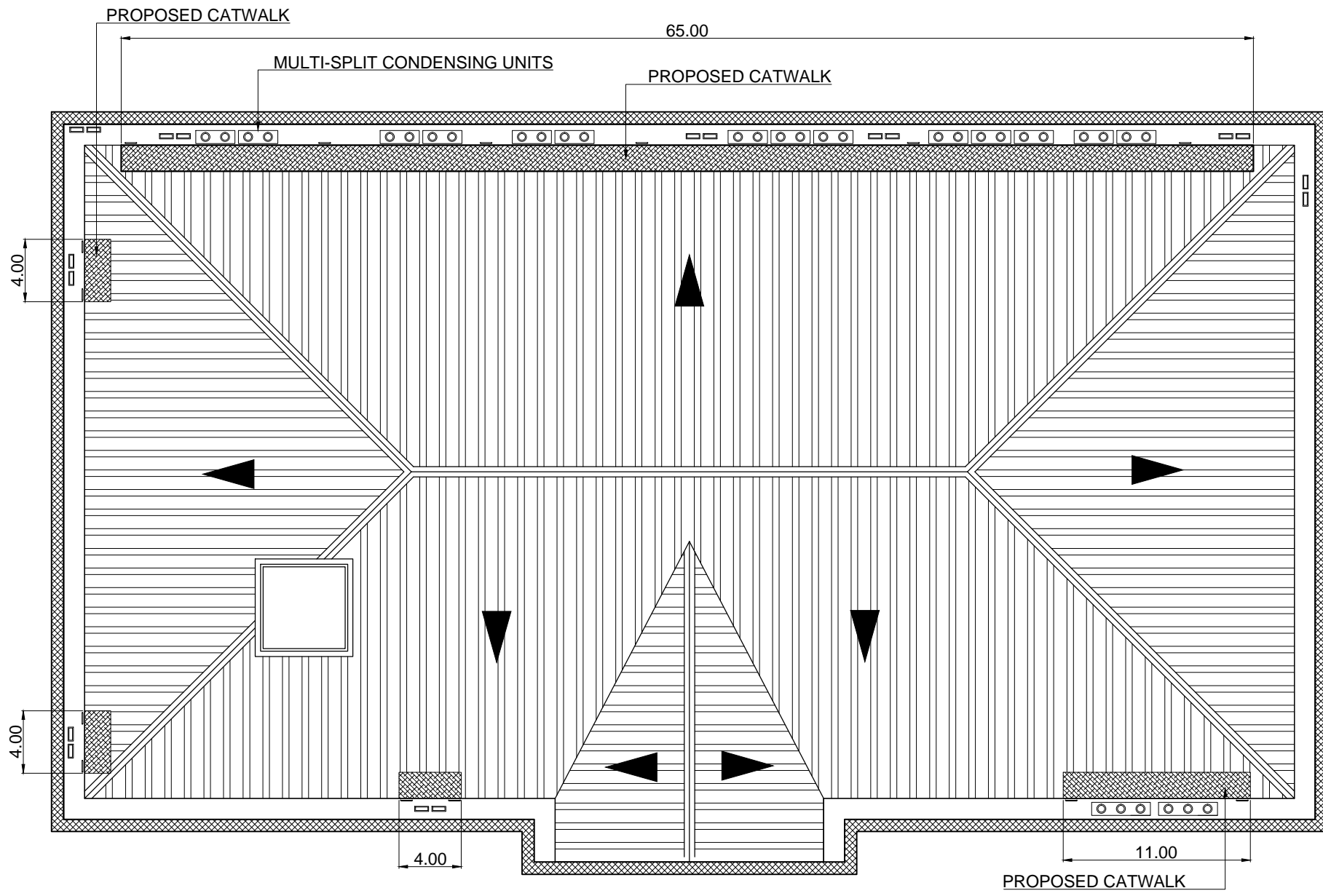

2  
S 1

**PROPOSED CATWALK LAYOUT**

SCALE : NTS

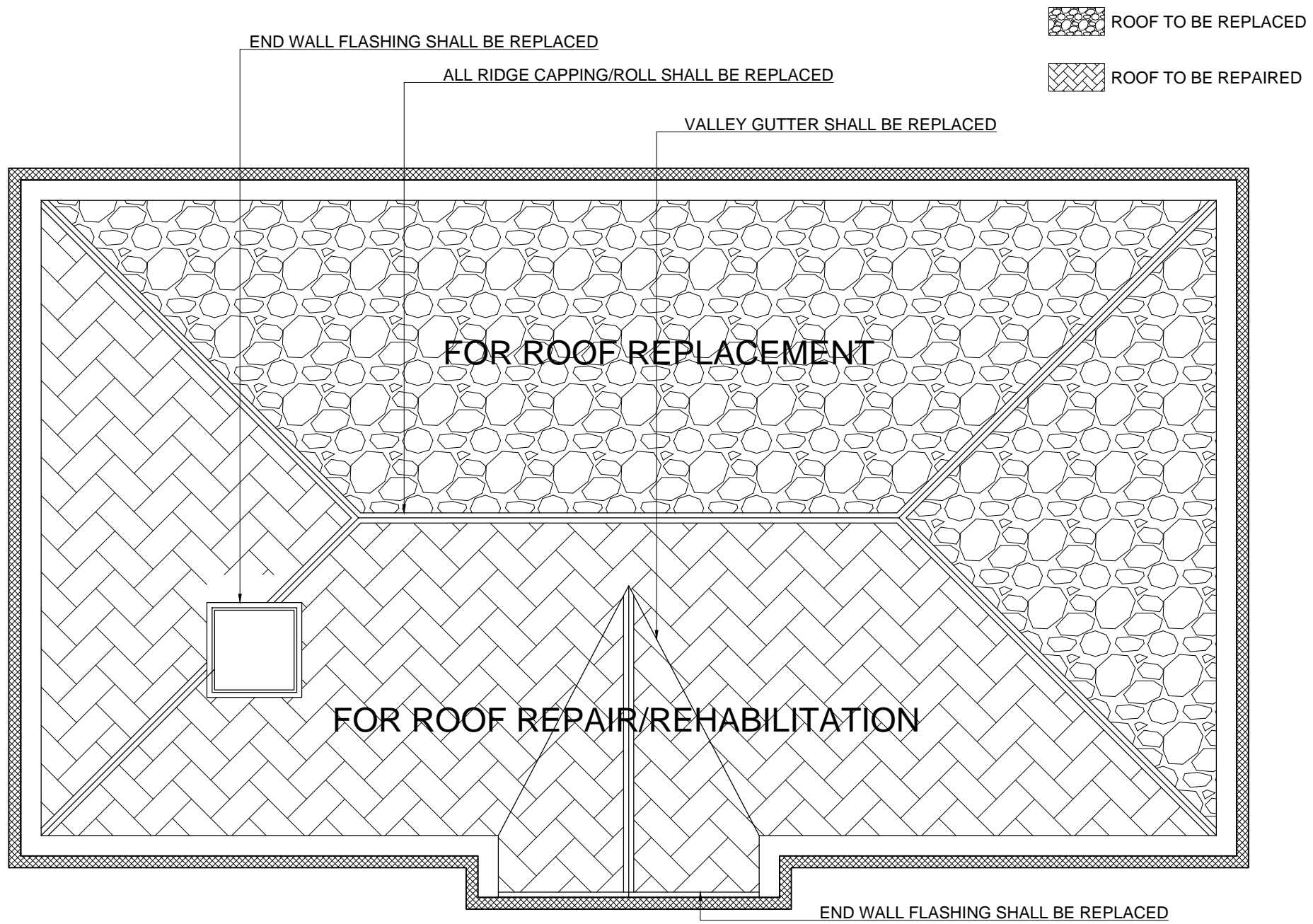

3  
S 1  
PROPOSED REPAIR/REPLACEMENT OF ROOF  
SCALE : NTS

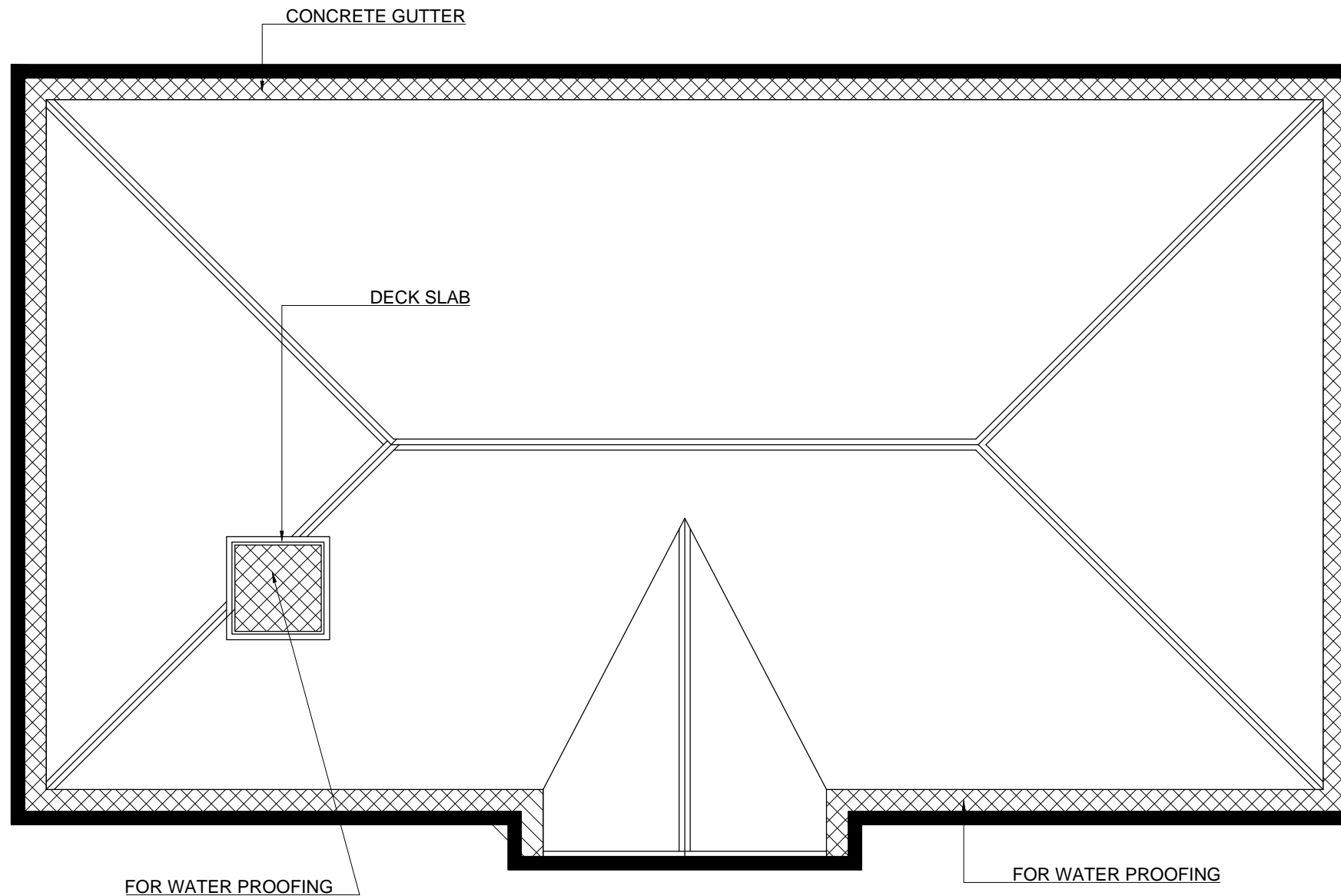

4  
S 1 PROPOSED RE-APPLICATION OF WATER PROOFING PAINT  
SCALE: NTS



REPUBLIC OF THE PHILIPPINES  
**Department of Budget and Management**  
 BONCODIN HALL, GENERAL SOLANO STREET, SAN MIGUEL, Manila

Project Title:  
 REPAIR/REHABILITATION OF  
 DBM BUILDING II ROOFS AND GUTTERS  
 AND INSTALLATION OF ROOF CATWALK

PREPARED BY:  
**ENGR. ARGEE STA BARBARA**  
 Building Maintenance Supervisor

RECOMMENDING APPROVAL:  
**SOFIA C. YANTO**  
 Director, Administrative Service

APPROVED BY:  
**HON. FLORENCIO B. ABAD**  
 Secretary, Department of Budget and Management

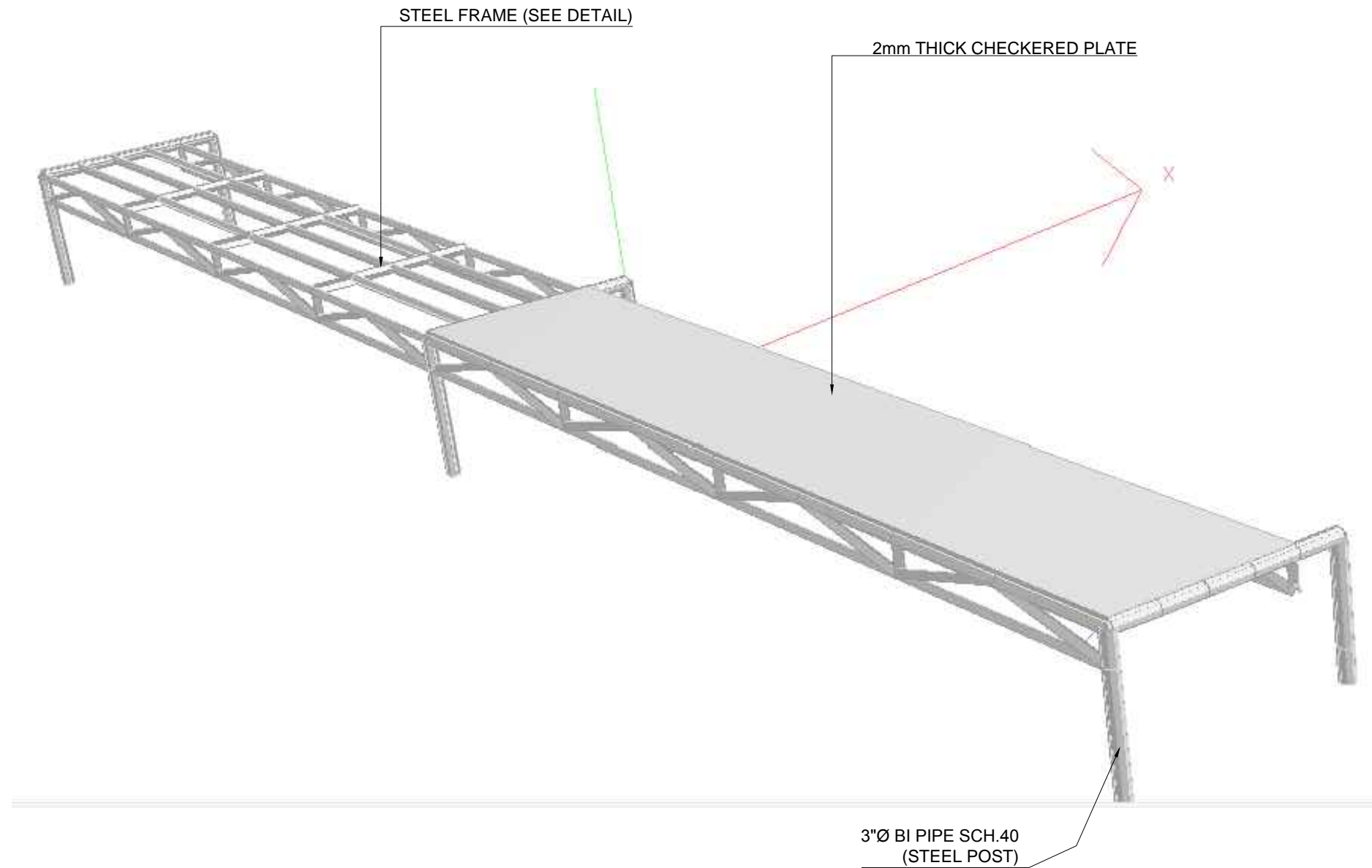

5  
S  
1
**PERSPECTIVE VIEW OF CAT WALK**  
 SCALE : NTS



REPUBLIC OF THE PHILIPPINES  
**Department of Budget and Management**  
 BONCODIN HALL, GENERAL SOLANO STREET, SAN MIGUEL, Manila

Project Title:  
 REPAIR/REHABILITATION OF  
 DBM BUILDING II ROOFS AND GUTTERS  
 AND INSTALLATION OF ROOF CATWALK

PREPARED BY:  
**ENGR. ARGEE STA BARBARA**  
 Building Maintenance Supervisor

RECOMMENDING APPROVAL:  
**SOFIA C. YANTO**  
 Director, Administrative Service

APPROVED BY:  
**HON. FLORENCIO B. ABAD**  
 Secretary, Department of Budget and Management

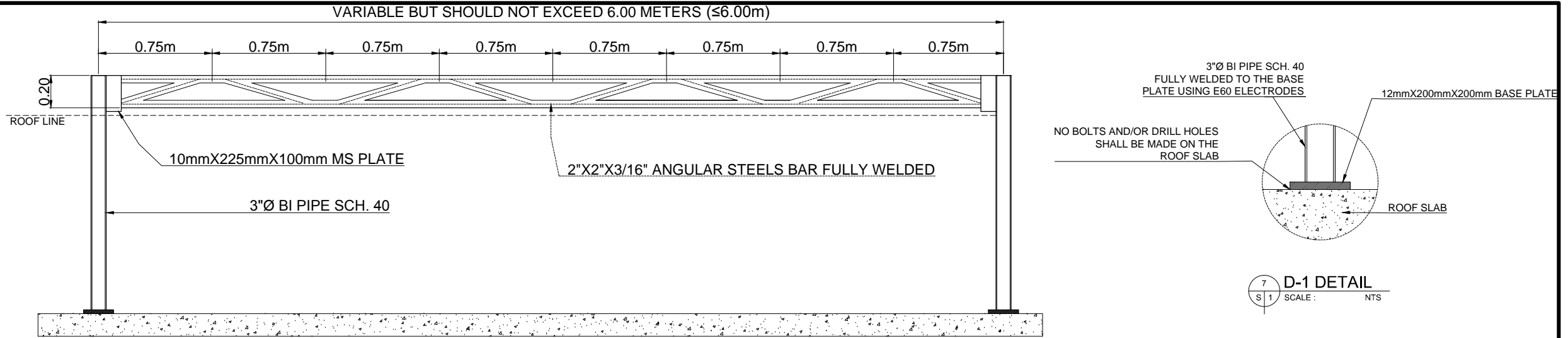

8 TYPICAL TRUSS BEAM DETAIL  
SCALE: NTS

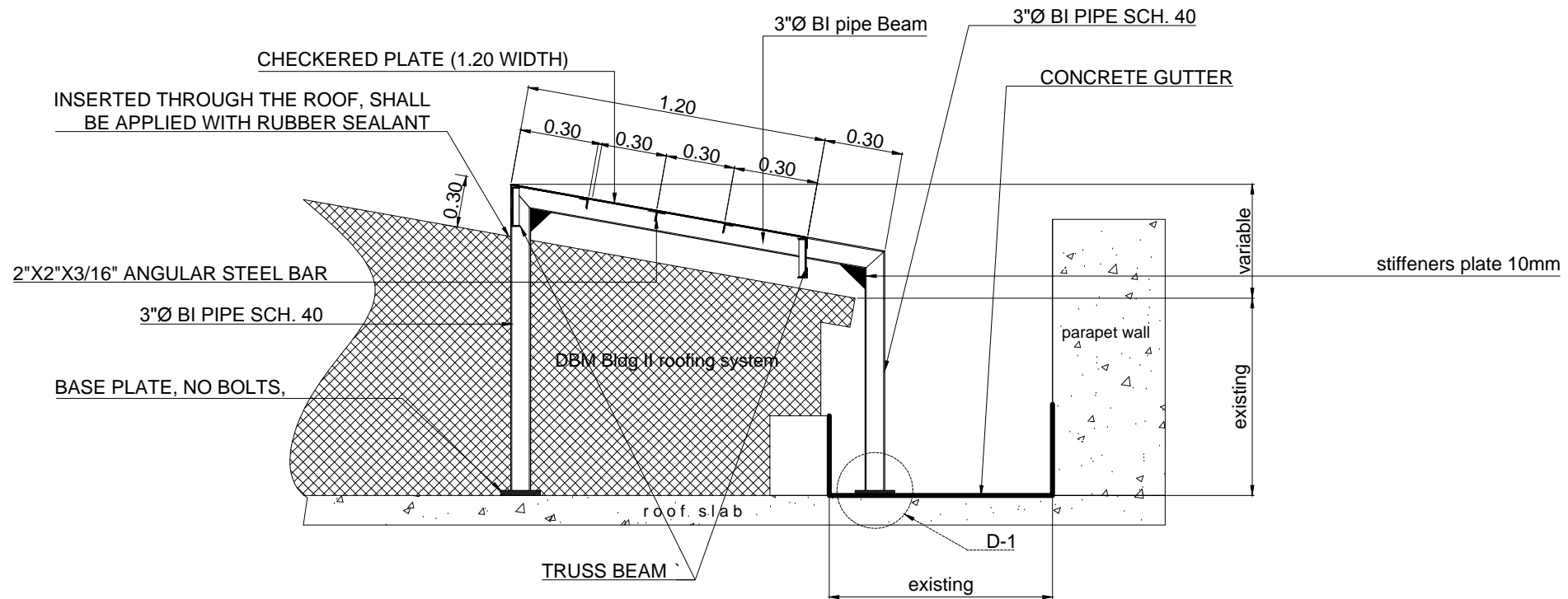

6 ELEVATION PLAN OF CATWALK  
SCALE: NTS

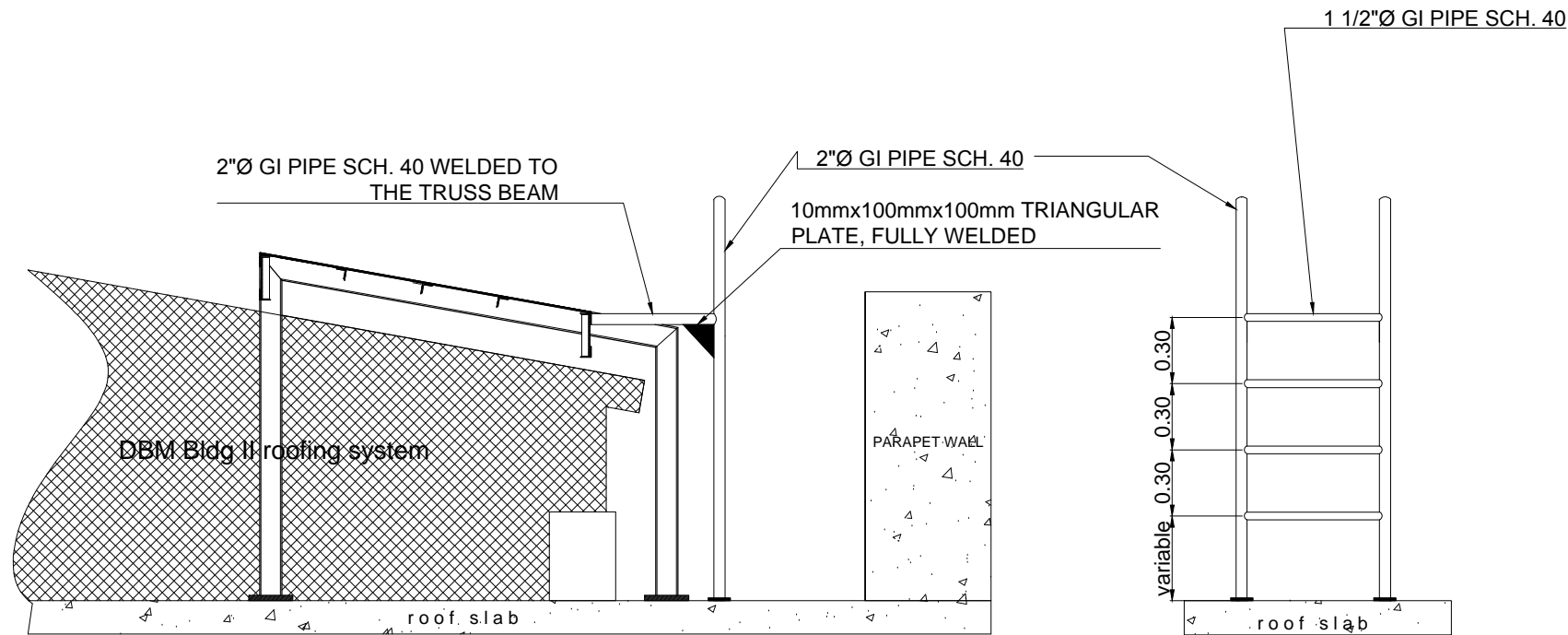

10 STEEL LADDER DETAIL  
 S 1 SCALE: NTS

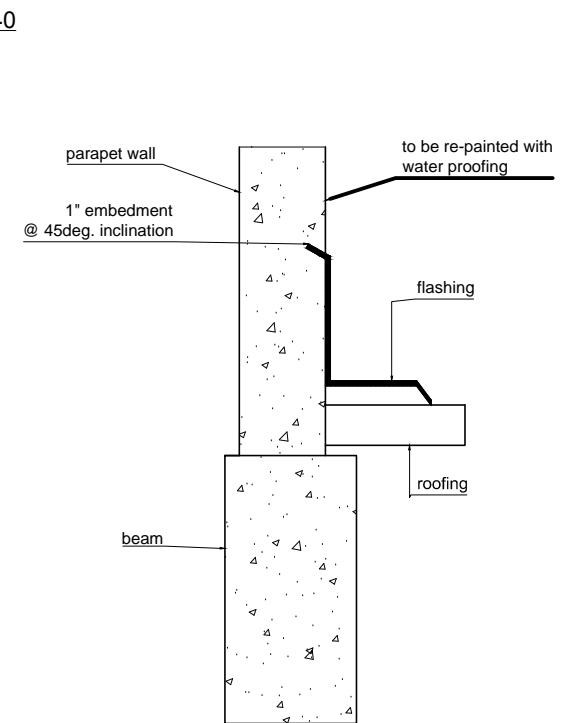

9 END WALL FLASHING DETAIL  
 S 1 SCALE: NTS



REPUBLIC OF THE PHILIPPINES  
 Department of Budget and Management  
 BONCODIN HALL, GENERAL SOLANO STREET, SAN MIGUEL, Manila

Project Title:  
 REPAIR/REHABILITATION OF  
 DBM BUILDING II ROOFS AND GUTTERS  
 AND INSTALLATION OF ROOF CATWALK

PREPARED BY:  
 ENGR. ARGEE STA BARBARA  
 Building Maintenance Supervisor

RECOMMENDING APPROVAL:  
 SOFIA C. YANTO  
 Director, Administrative Service

APPROVED BY:  
 HON. FLORENCIO B. ABAD  
 Secretary, Department of Budget and Management



1 SITE DEVELOPMENT PLAN  
S 1 SCALE: NTS



REPUBLIC OF THE PHILIPPINES  
**Department of Budget and Management**  
 BONCODIN HALL, GENERAL SOLANO STREET, SAN MIGUEL, Manila

Project Title:  
 REPAIR/REHABILITATION OF  
 DBM BUILDING II ROOFS AND GUTTERS  
 AND INSTALLATION OF ROOF CATWALK

PREPARED BY:  
**ENGR. ARGEE STA BARBARA**  
 Building Maintenance Supervisor

RECOMMENDING APPROVAL:  
**SOFIA C. YANTO**  
 Director, Administrative Service

APPROVED BY:  
**HON. FLORENCIO B. ABAD**  
 Secretary, Department of Budget and Management